



**D-LP 32/
DS-TS 32**

Operating instructions

en



- ① Hydraulic unit
- ② Remote control unit
- ③ Rail
- ④ Saw blade
- ⑤ Blade guard
- ⑥ Hydraulic hoses
- ⑦ End stop
- ⑧ Rail support

1. General information	4
2. Description	5
3. System components, tools and accessories	13
4. Technical data	17
5. Safety precautions	21
6. Before use	27
7. Operation	35
8. Care and maintenance	43
9. Troubleshooting	45
10. Disposal	50
11. Manufacturer's warranty – tools	51
12. EU declaration of conformity (original)	52

1. General information

1.1 Safety notices and their meaning

It is essential that the operating instructions are read before the equipment is operated for the first time. Always keep these operating instructions together with the equipment. Ensure that the operating instructions are with the equipment when it is given to other persons.

DANGER

Draws attention to imminent danger that will lead to serious bodily injury or fatality.

WARNING

Draws attention to a potentially dangerous situation that could lead to serious personal injury or fatality.

CAUTION

Draws attention to a potentially dangerous situation that could lead to slight personal injury or damage to the equipment or other property.

NOTE

Draws attention to an instruction or other useful information.

1.2 Explanation of the pictograms and other information

Warning signs



General warning



Warning: electricity



Warning: avoid hand injuries



Warning: Risk of cutting injury

Obligation signs



Wear protective gloves.



Wear eye protection.



Wear a hard hat.



Wear safety footwear.



Wear respiratory protection.



Wear ear protection.

Symbols



Read the operating instructions before use



Return waste material for recycling
Return waste material for recycling

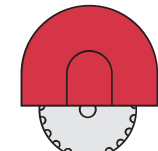

Always fit the blade guard

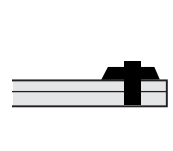

Always fit the rail end stops

A

Amps

V

Volts

Hz

Hertz

kW

Kilowatts

mm

Millimeters

/min

Revolutions per minute

rpm

Revolutions per minute

l/min

Liters per minute

bar

Bar



Alternating current

Description	2.1 Areas of application	6
	2.2 D-LP 32/DS-TS 32 hydraulic saw system components	6
	2.3 Parts and operating controls	8

2. Description

2.1 Areas of application

The D-LP 32/DS-TS32 is a medium to heavy-duty, high-performance wall saw system for use with saw blades of up to 1600 mm dia. It is capable of cutting to a depth of 73 cm.

The D-LP 32 hydraulic unit has a nominal power of 32 kW at 63 amps but can also be operated on 32 amp mains supplies.

Its modular design permits rapid assembly and use for many different applications. The DS-TS 32 saw head, for example, can be used to power the Hilti DS-WSS 30 high-performance wire saw system.

Using the D-RC-LP 32 digital remote control unit to adjust the infinitely variable oil flow rate, the operator can select the optimum speed and most suitable rate of advance. This feature ensures optimum efficiency for wall sawing, hydraulic coring, plunge sawing or wire sawing.

2.2 D-LP 32/DS-TS32 hydraulic saw system components

The basic diamond saw system consists of the following components:

- 1 D-LP 32 hydraulic unit
- 2 D-RC-LP 32 remote control unit
- 3 DS-TS 32 saw head
- 4 D-R 200L rail
- 5 DS-C...H saw blade
- 6 DS-BG blade guard
- 7 D-PH/FH hydraulic hoses and water supply hose
- 8 DS-ES-L end stop (2 end stops supplied with each D-R..L rail)
- 9 D-LP 32/DS-TS 32 tool set

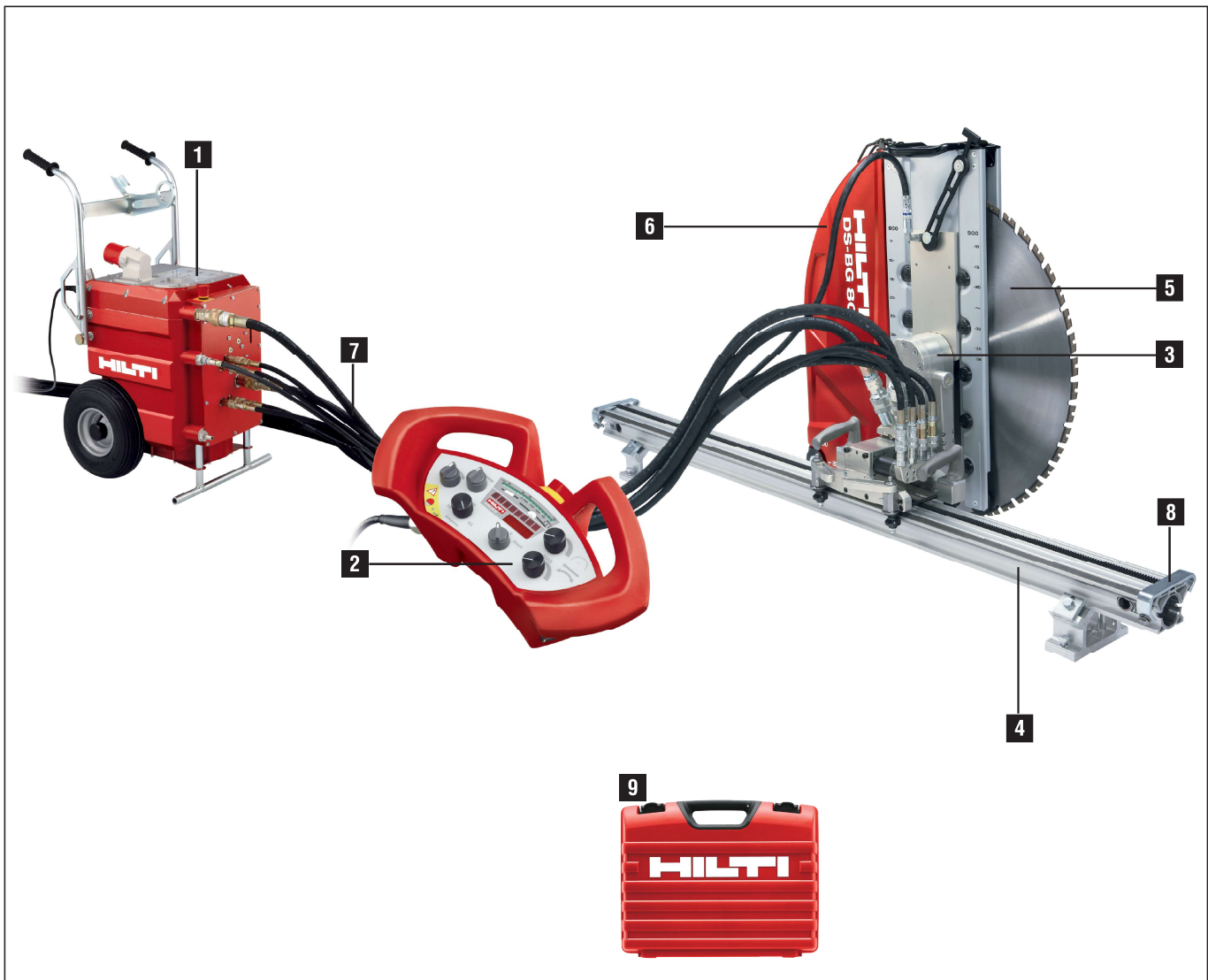

2.2.1 D-LP 32/DS-TS, PS, WSS and DD modular system

D-LP32/DS-TS 32 Wall saws

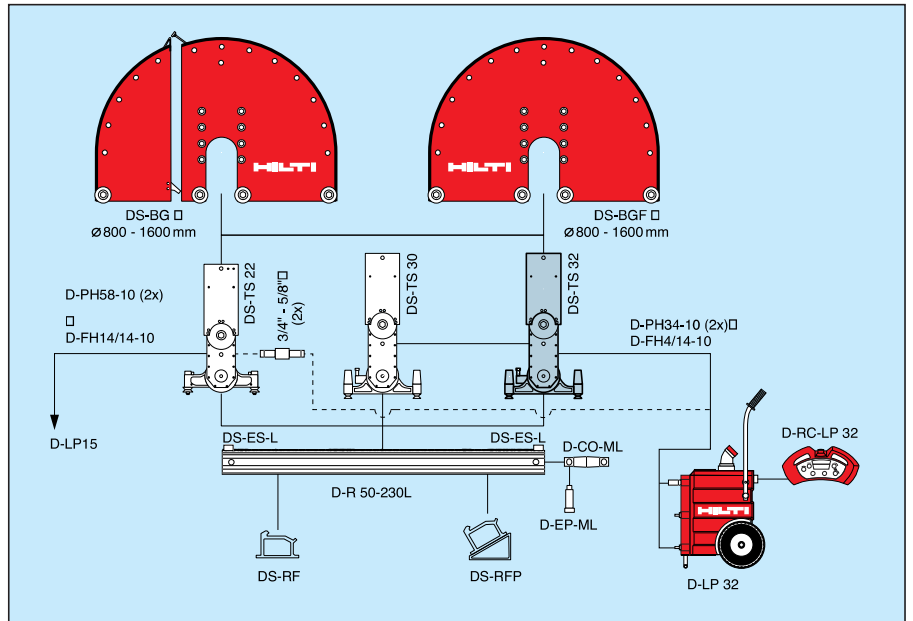

D-LP 32/DD-750 HY/DS-PS 30 Hydraulic core drilling rig Plunge saw

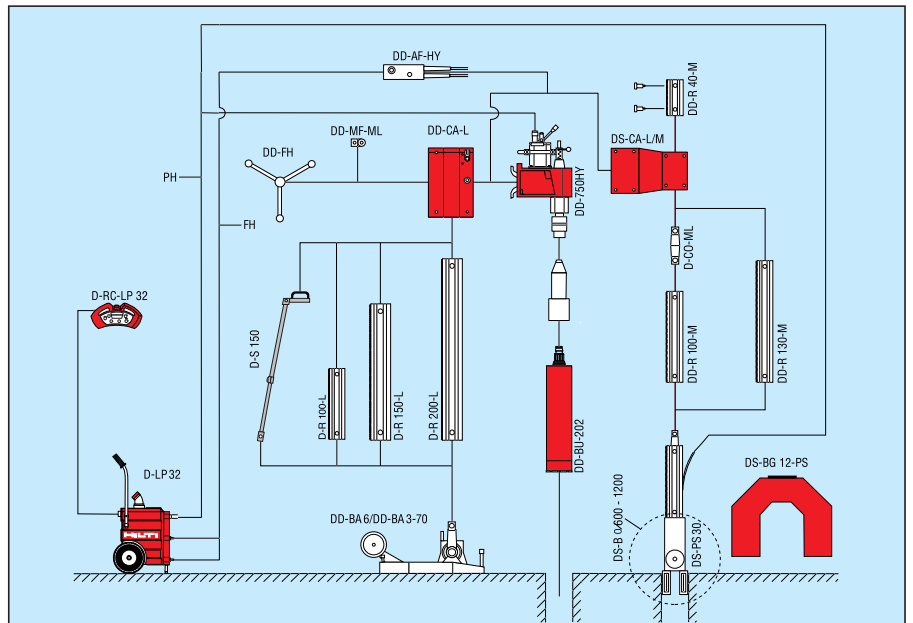

D-LP 32/DS-TS 32/DS-WSS 30 Wire saw

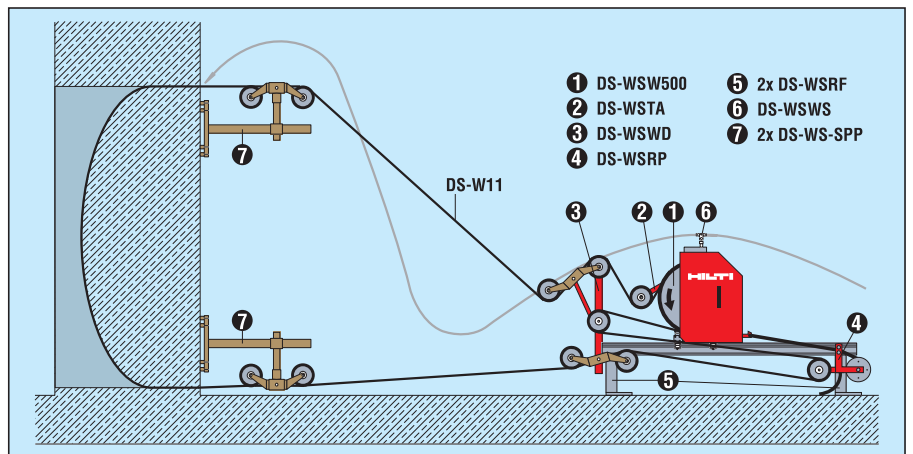

2. Description

2.3 Parts and operating controls

2.3.1 D-LP 32 hydraulic unit

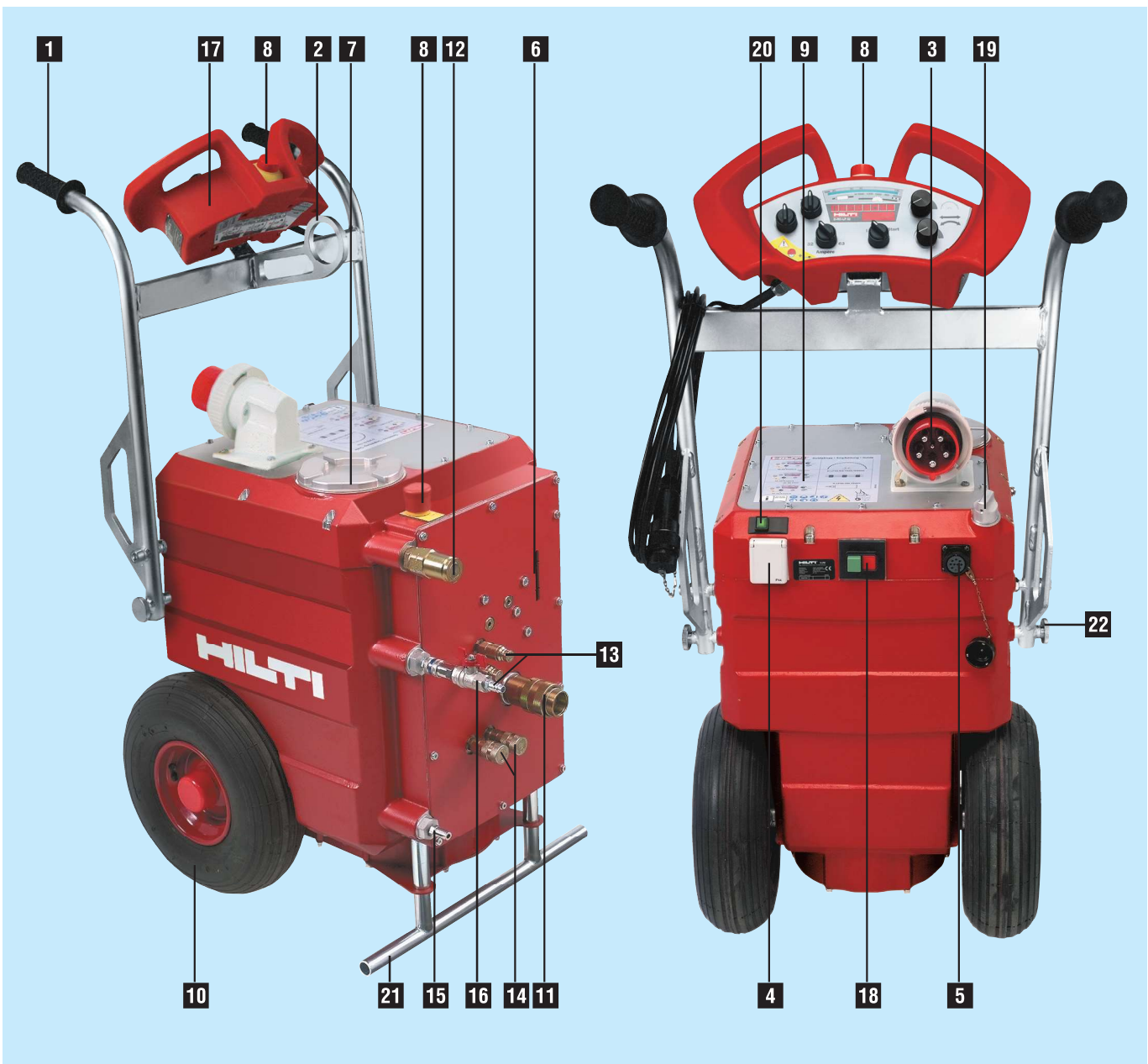

- 1** Transport handle, hinged
- 2** Lifting point for transport by crane
- 3** 400 V 63 A socket, mains supply (Euro standard socket as per EN CEE 63)
- 4** 230 V socket
- 5** Socket for D-RC-LP32 remote control unit
- 6** Oil level sight glass
- 7** Oil filter cover
- 8** Emergency off switch
- 9** Guidelines for use (sticker)
- 10** Wheels with puncture-proof tyres
- 11** PH $\frac{3}{4}$ " coupling for pressure hose
- 12** PH $\frac{3}{4}$ " coupling for return hose
- 13** FH $\frac{1}{4}$ " couplings \longleftrightarrow for advance control hoses
- 14** FH $\frac{1}{4}$ " couplings for \curvearrowright saw arm
- 15** Coupling for water supply from the site
- 16** Water supply to saw head (with water flow rate regulation)
- 17** D-RC-LP 32 remote control unit
- 18** On / off control switch
- 19** Cap / oil filler neck
- 20** 230 V socket overload reset button
- 21** Front support
- 22** Hinged transport handle locking mechanism







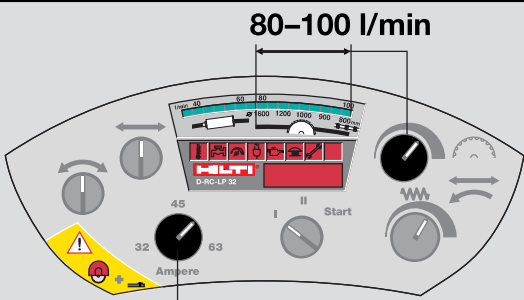
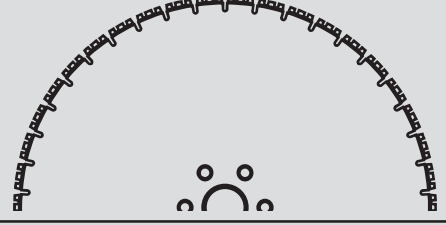
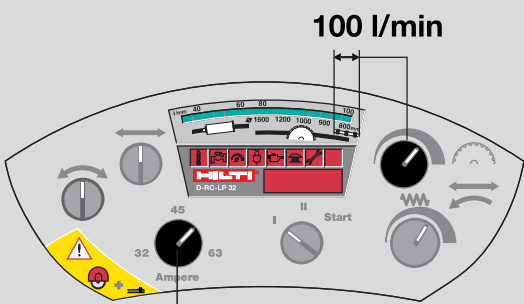

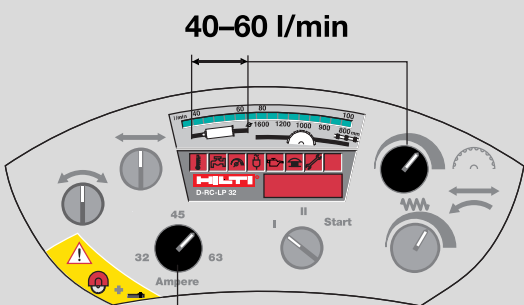
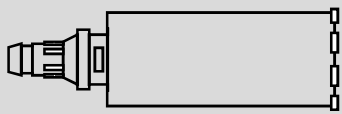
2.3.2 Guidelines for use (sticker on D-LP 32 hydraulic unit)



Guideline • Richtlinie • Guide

<p>80–100 l/min</p>  <p>32-63 Ampere</p>	<p>D-LP 32/DS-TS 32</p> 
<p>100 l/min</p>  <p>45-50 Ampere</p>	<p>D-LP 32/DS-TS 32/WSS 30</p> 
<p>40–60 l/min</p>  <p>32-45 Ampere</p>	<p>D-LP 32/DD 750-HY</p> 



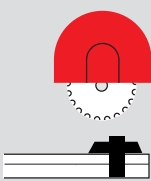

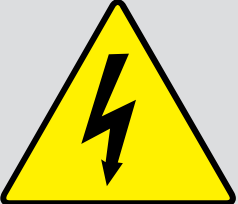

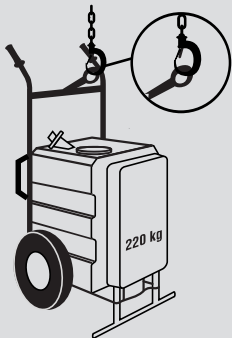
220 kg

356749

2. Description

2.3.3 D-RC-LP32 remote control

- 1** Remote control unit casing
- 2** Grips / control panel protection bars
- 3** Display and operating controls
- 4** Attachment point for belt fastener
- 5** Shoulder belt with fastener
- 6** Rear side of remote control unit: Sawing guidelines
- 7** Emergency OFF switch

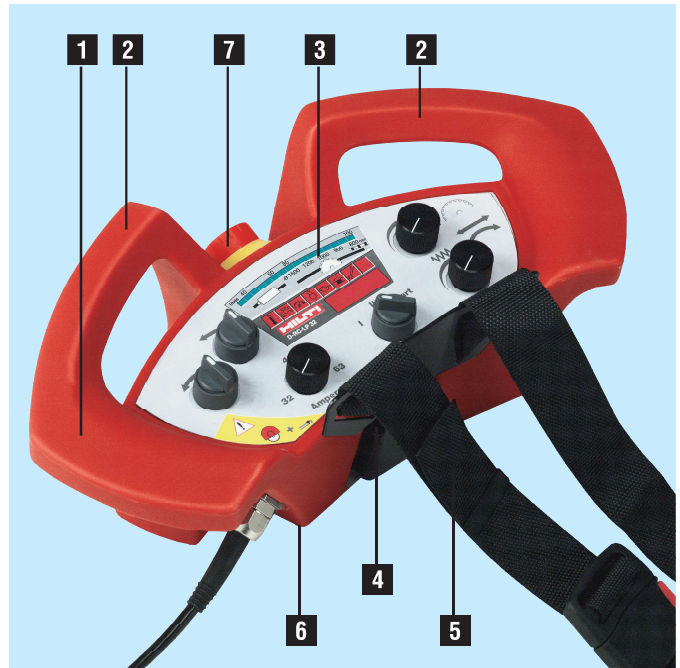

2.3.4 Sawing guidelines

See sticker on the rear of the D-RC-LP 32 remote control unit.

- 1** Cutting depth for soft concrete / masonry
- 2** Cutting depth for hard concrete
- 3** Optimum blade diameter sequence
- 4** Plunge depth for initial guide cut
- 5** Plunge depth for subsequent cuts
- 6** Cut no. I - saw arm trailing
- 7** Cut no. II - saw arm leading
- 8** Cut no. III - saw arm trailing
- 9** Direction of blade rotation (counterclockwise, as seen from side where blade is fitted)
- 10** Recommended oil flow rate in l/min. (speed) for corresponding blade dia. (mm)

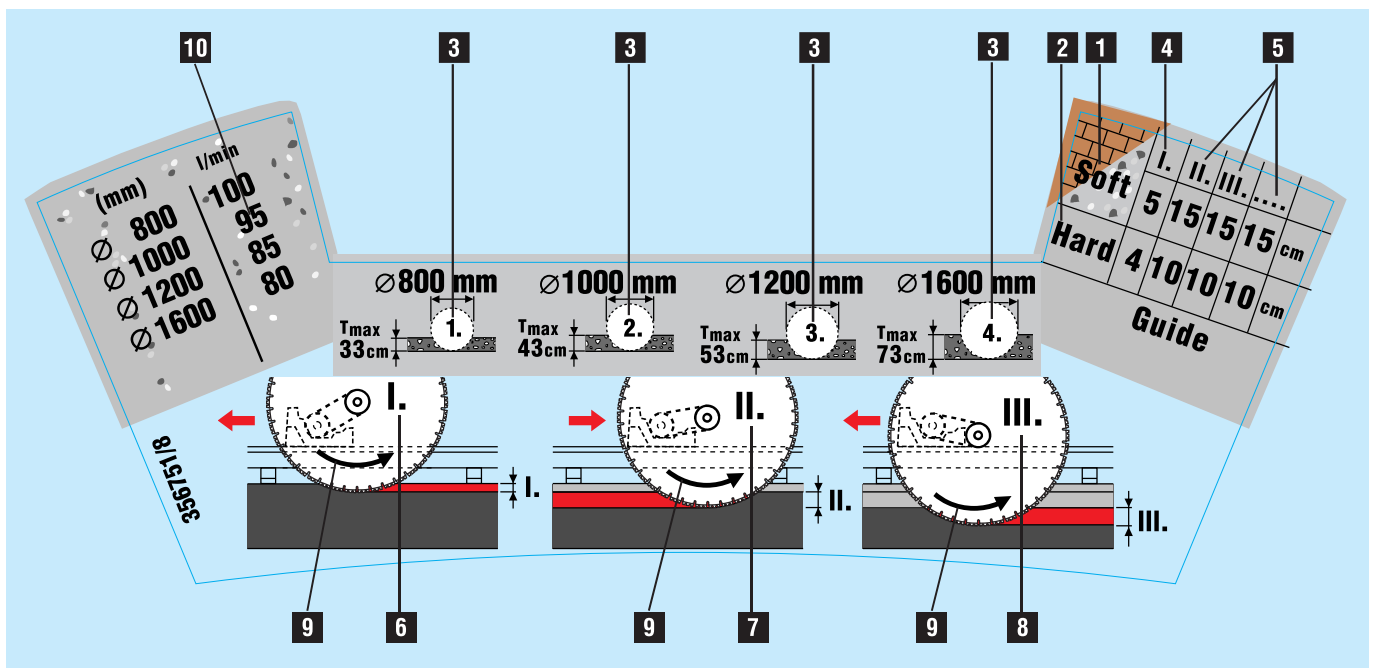
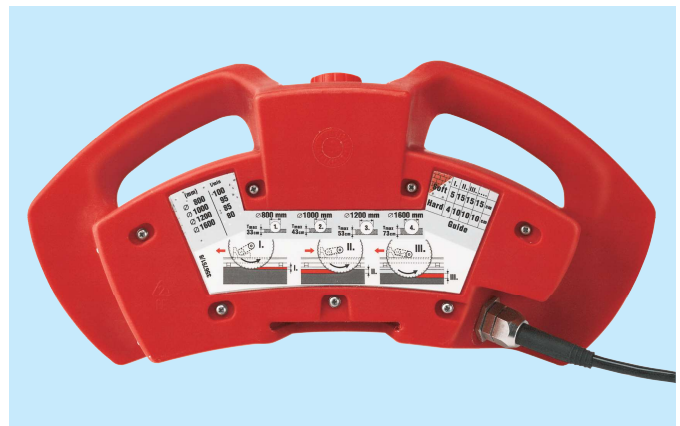

2.3.5 Display, symbols and warning lamps on the D-RC-LP 32

- 1 Hydraulic unit starting switch (OFF/ON/Start)
- 2 Oil flow rate (blade drive speed) 30–100 l/min. (green spot lights up)
- 3 Direction of blade plunge movement (right / left)
- 4 Direction of advance (left / right or up / down)
- 5 Speed control for 3 and 4
- 6 Power control (amps), depending on mains supply
- 7 Emergency OFF switch
- 8 Oil flow rate indicator
- 9 Position of green spot corresponding to saw blade diameter
- 10 Temperature indicator, lights briefly before cut-out on overheating
- 11 Water cooling: lights when unit is inadequately cooled
- 12 Zero position: lights when one of the control knobs is not in the "zero" or "neutral" position
- 13 Mains supply / warning lamp
- 14 Oil level: lights when oil level is too low
- 15 Emergency OFF: lights when button is pressed in
- 16 Service indicator: lights when service is due
- 17 Operating hours indicator / working pressure (bar)
- 18 Operating range for sawing
- 18A Operating range for wire sawing
- 19 Operating range for core drilling

2.3.6 Warnings

- 20 Warnings
- 21 General warning
- 22 Always fit the blade guard
- 23 Always fit the rail end stops

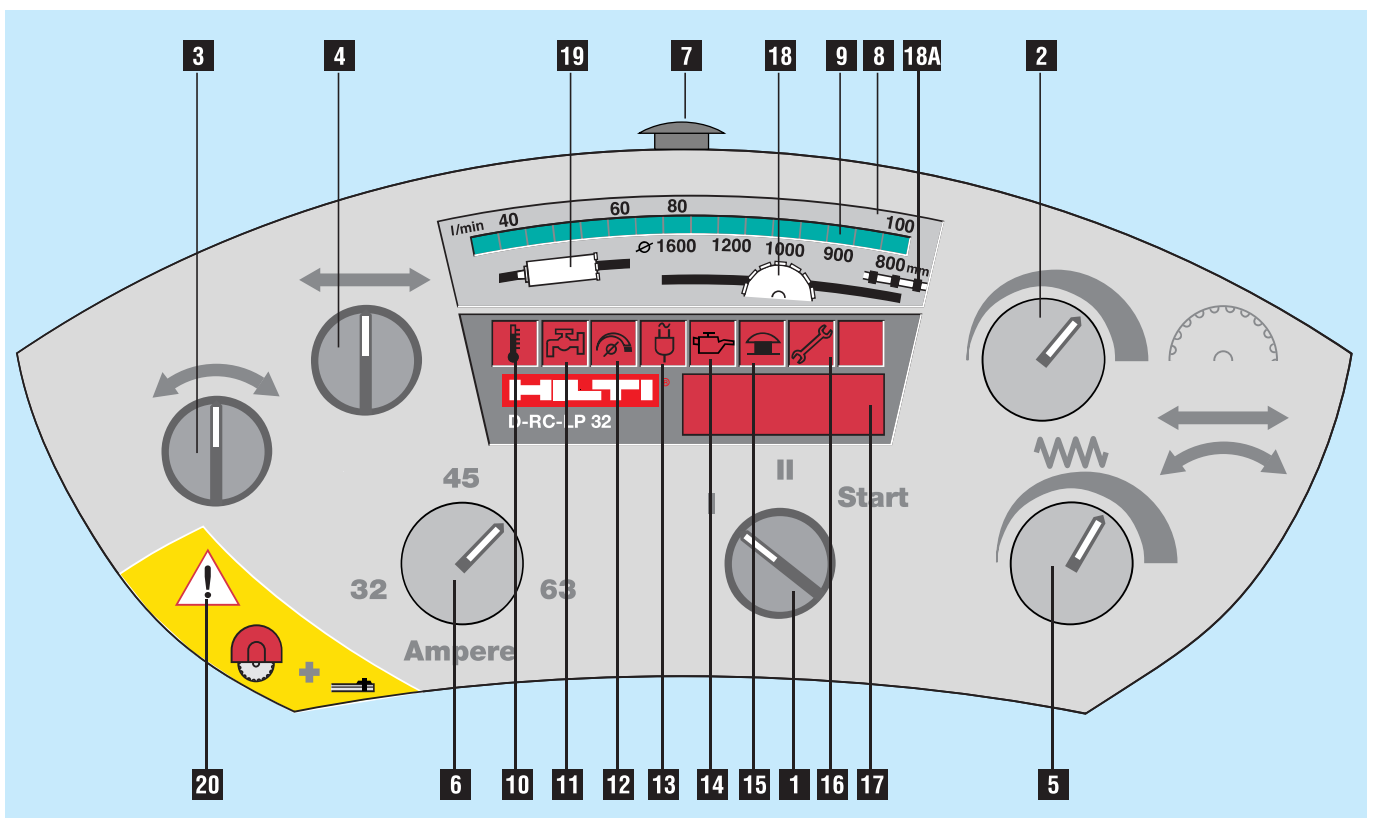
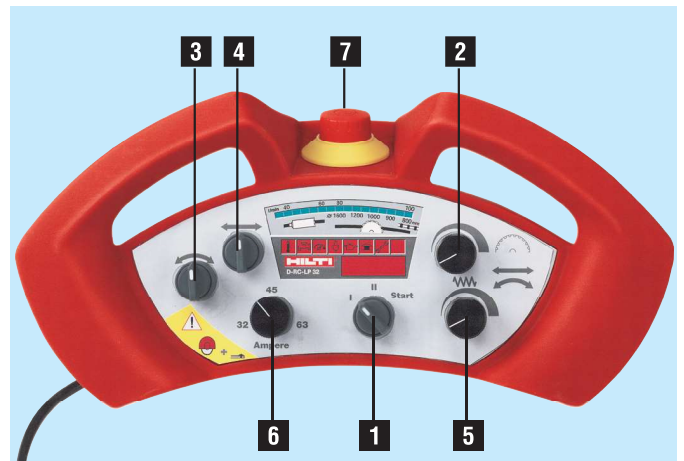
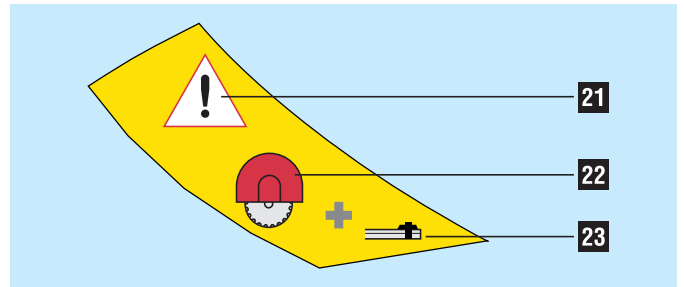

2. Description

2.3.7 DS-TS 32 saw head

- 1** Saw arm with built-in motor
- 2** Blade guard holder (moves with the saw arm)
- 3** Carriage with wear-resistant cam-action steel rollers **12**
- 4** Cam-action roller locking lever
- 5** Hydraulic coupling (PH $\frac{3}{4}$ ") – pressure hose
- 5A** Direction of oil flow
- 6** Hydraulic coupling (PH $\frac{3}{4}$ ") – return hose
- 7** Hydraulic couplings (FH $\frac{1}{4}$ ") – advance
- 8** Hydraulic couplings (FH $\frac{1}{4}$ ") – saw arm pivot
- 9** Water supply
- 9A** Water control valve: may be fitted at blade guard or at hydraulic unit
- 10** Saw blade mounting flange with special M12×25 / 10.9 grade steel screw **18**
- 11** Grips
- 12** Cam-action rollers
- 13** Clamping screw for positioning blade guard holder and blade guards
- 14** Cam-action roller lockbutton

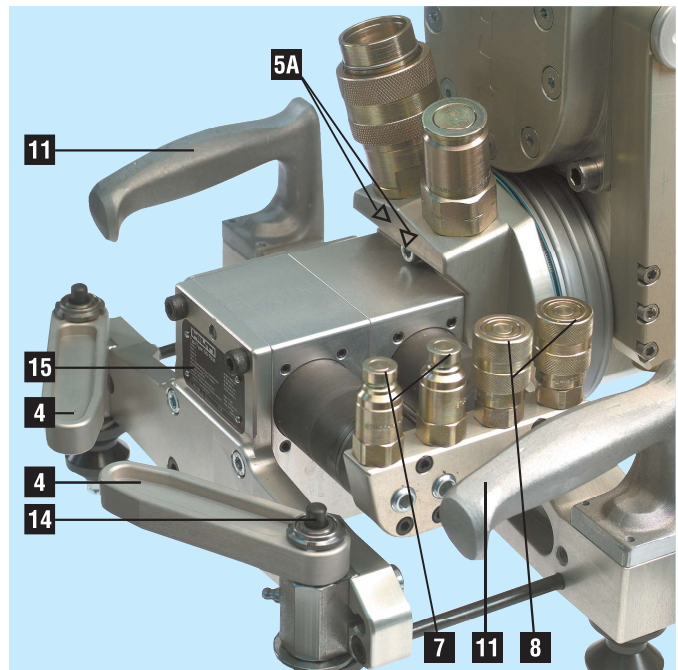

- 15** Rating plate
- 16** Grease nipple for cam-action roller bearing
- 17** Holder for blade guard rubber
- 18** Special M 12×25 / 10.9 screw

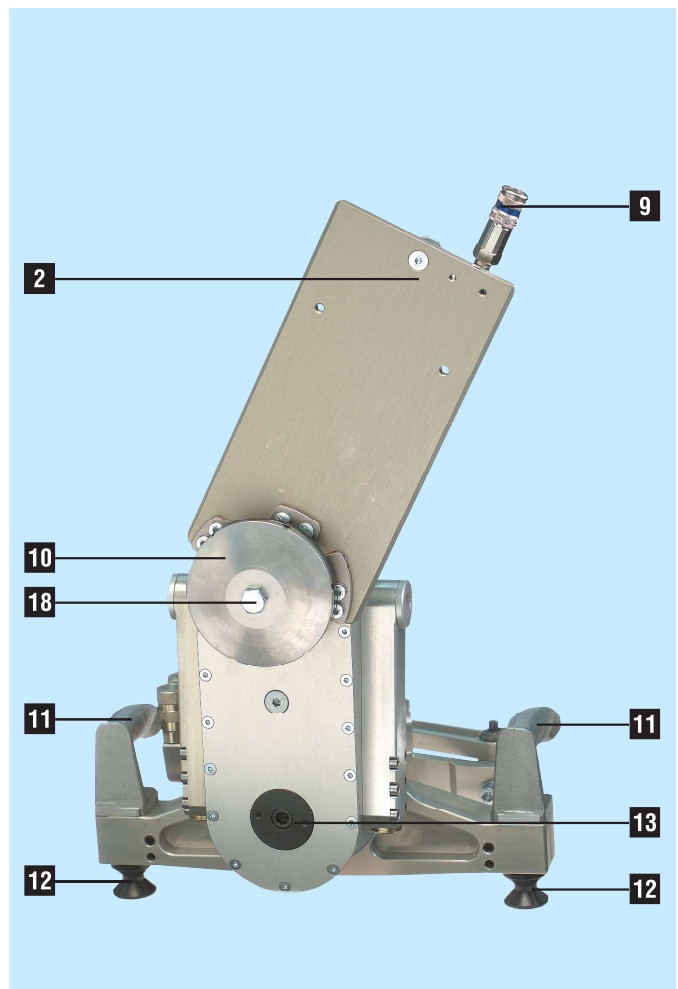
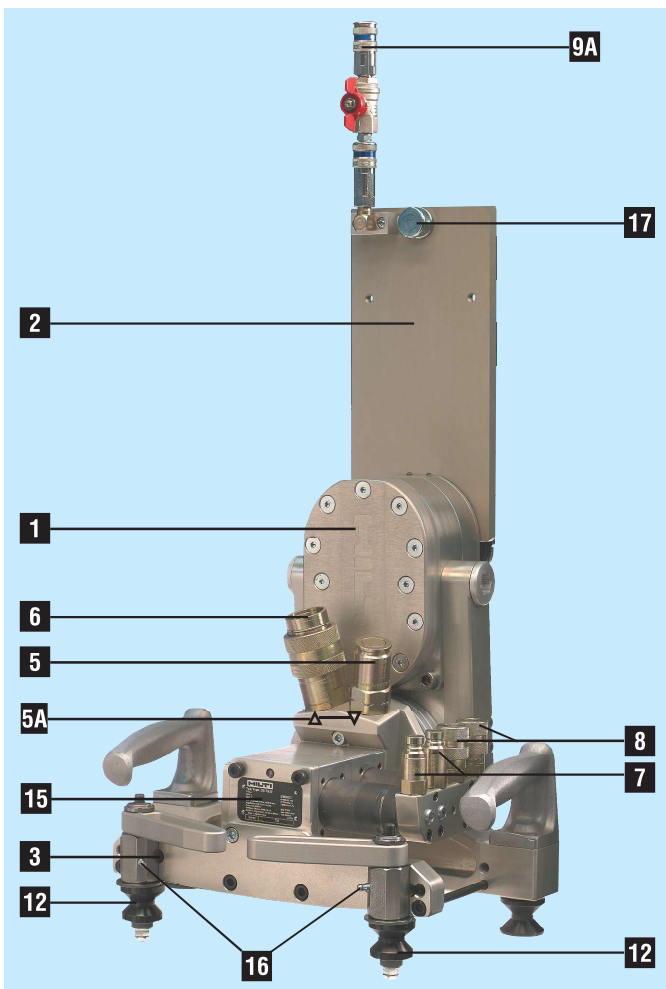

3. System components, tools and accessories

System components, tools and accessories

3.1 Hydraulic hoses and hydraulic hose set	14
3.2 D-R..L rails, DS-ES-L end stops, DS-RF rail supports and DS-RFP angular cutting plate	14
3.3 DS-BG / BGF blade guard	14
3.4 DS-FCA-110 flush-cutting flange	15
3.5 Diamond saw blades	15
3.6 Accessories, D-LP 32/DS-TS 32 tool set	16

3. System components, tools and accessories

3.1 Hydraulic hoses and hydraulic hose set



DS-PH34-10
hydraulic hose set



DS-FH4/14-10
hydraulic hose set (with water supply hose)

3.2 D-R..L rails, DS-ES-L end stop, DS-RF rail support and DS-RFP angular cutting plate



D-R..L

D-R50L rail
D-R100L rail
D-R150L rail
D-R200L rail
D-R230L rail
DS-ES-L end stop

Accessories for securing and operating the saw



DS-ES-L

DS-RF

DS-RFP

3.3 DS-BG / BGF blade guard

Item no.	Designation	Use
238000	DS-BG65 blade guard	Blade guard for blades up to 650 mm dia.
238002	DS-BG80 center section	Blade guard for 600 to 900 mm dia. saw blades *
238003	DS-BG80 side section	Blade guard for 600 to 900 mm dia. saw blades
238004	DS-BG120 center section	Blade guard for 1000 to 1200 mm dia. saw blades *
238005	DS-BG120 side section	Blade guard for 1000 to 1200 mm dia. saw blades
333883	DS-BG16 blade guard	Blade guard for 1200 to 1600 mm dia. saw blades
Item no.	Designation	Use
238006	DS-BGF80 center section	Blade guard for 600 to 900 mm dia. saw blades for flush cutting *
238007	DS-BGF80 side section	Blade guard for 600 to 900 mm dia. saw blades for flush cutting
238008	DS-BGF120 center section	Blade guard for 1000 to 1200 mm dia. saw blades for flush cutting *
238009	DS-BGF120 side section	Blade guard for 1000 to 1200 mm dia. saw blades for flush cutting
256237	DS-BGF16 blade guard	Blade guard for 1200 to 1600 mm dia. saw blades for flush cutting

* Only to be used with the corresponding side sections!

DS-BG



DS-BGF



3. System components, tools and accessories

3.4 DS-FCA-110 flush-cutting flange

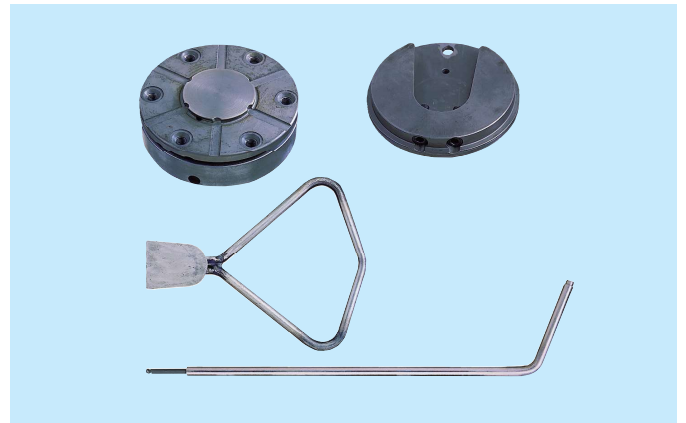

3.5 Diamond saw blades

We recommend Hilti CS-H, CM-H or CH-H saw blades for use with the D-LP32/DS-TS32. The saw blades can be selected from the following table, taking material, steel content and dimensions into account.

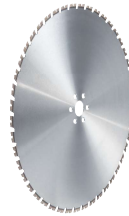

Recommendations for use: Which specification for which material?

Specification	Cutting characteristics	Type of concrete	Reinforcement
CS-H / UP	Fast-cutting	Soft aggregates	Normal to high
CM-H / UP	Well-balanced, good speed and life	Hard aggregates	Normal
CH-H / SP	Fast-cutting and long life	Soft to very hard aggregates	Normal to high

Important

- Sawing at a lower speed (reduced saw blade r.p.m.) is usually advantageous when difficult conditions such as high steel content or hard aggregates etc. are encountered.
- Safety precaution: Keep to the recommended settings in order to ensure that blade peripheral speed remains within the safe range for the saw blade used.

3. System components, tools and accessories

3.6 D-LP 32 / DS-TS32 tool set

Ordering designation	Qty.	Use
D-LP32/DS-TS32 tool set	1	LP 32/TS32 hydr. saw system
comprising:		
Hilti plastic toolbox with insert	1	Operator
Accessories, list of contents and their use	1	Operator
Folding rule, 2 m	1	Operator
STOF cleaning cloth	1	Operator
Flat brush	1	Operator
Hilti spray	1	Operator
Hilti grease dispenser	1	Operator
Ear protectors	1	Operator
HSD-G M12 setting tool	1 ①	Setting anchors
BB blow out pump	1 ②	Anchor holes
Spirit level	1	Assembling rails
Open-end / ring wrench, 19 mm	1	Assembling rails
Open-end / ring wrench, 18 mm	1	Assembling rails
Screwdriver	1	Assembly
Hammer 1½ kg	1	Setting anchors
Socket, 19 mm AF	1	Assembling rails
Extension, ½" square drive	1	Assembling rails
Ratchet, ½" square drive	1	Assembling rails
D lever with ½" square drive	1	Assembling rails
D-CP-ML rail clamp	1 ③	Mounting rails
Hex. screw, M12×40/8.8	8	Fastening rail support
Hex. screw, M12×70/8.8	8	Fastening rail support
Washer	8	Fastening rail support
Clamping piece	1	Spare part rail support
Washer, 12×18×1	3	Spare part rail support
Spring, 1×12×25	3	Spare part rail support
M12 nut with collar	8	Angular cutting plate
D-EP-ML ½" eccentric pin	3	Rail extension
D-CO-ML taper	1 ④	Rail extension
Rubber	2	Blade guard holder
Grip nut	1	Fastening blade guard
Hex. key, 4 mm	2	Eccentric rollers / covers
Hex. key, 10 mm	1	Fastening blade guard holder
DS hex. key with T-grip	1	Eccentric rollers
D-PRT pressure release valve FH ¼"	1 ⑤	Pressure release FH ¼"
D-PRT pressure release valve PH ¾"	1 ⑥	Pressure release PH ¾"
D-steel wedge 130×70×20	6 ⑦	Securing concrete block
Copper ring	5	Core bit extension
Special M 10 countersunk-head screw (6 screws)	1	Spare part, DS-FCA flange
Set of 3 seals	1	Spare part, DS-FCA flange
Special hex. screw, M 12×25/10.9	2	Spare part, mounting saw blade
Hose coupling, 15–24 mm	2	Attaching water hose

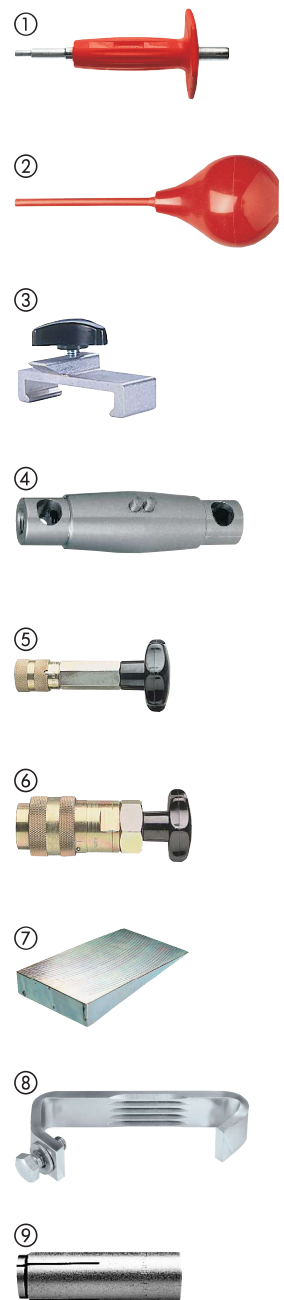

Additional accessories for the D-LP32/DS-TS32 (not included in the tool set)

Ordering designation	Qty.	Use
DS-ES-L end stop	2 ⑧	Securing carriage L
HKD-D M12×50 flush anchor	50 ⑨	16 mm dia. hole
Water valve Y-piece	1 ⑩	Water supply
Water valve	1 ⑪	Water supply
Water connector for saw head	1	Spare part for saw head
Hydraulic coupling, FH ¼" (female)	1	Spare part for FH ¼"
Hydraulic coupling, FH ¼" (male)	1	Spare part for FH ¼"
Hydraulic coupling, PH ¾" (female)	1	Spare part for PH ¾"
Hydraulic coupling, PH ¾" (male)	1	Spare part for PH ¾"
HVLP 46 hydraulic oil (25 litres)	1	Hydraulic unit
Sharpening plate, 319 × 319 × 18 mm	1	Saw blades, core bids
D-RC-Ext 10 extension cable, 10 m	1	For remote control unit
CEE 63 A plug socket (female)	1	Power extension cable
Shoulder belt with fastener RC-LP 32/TS 5-E	1 ⑫ ⑬	Spare part for remote control unit
Shoulder belt	1 ⑫	Spare part for 373243/5

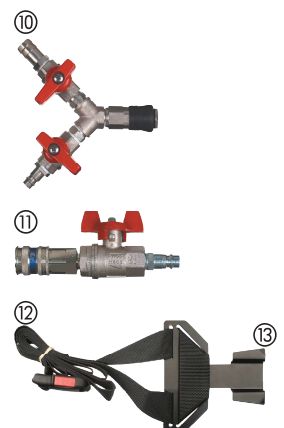

Technical data	4.1 Power supply	18
	4.2 Dimensions and weights	18
	4.3 IP enclosure protection code	18
	4.4 Climatic conditions for operation and storage	18
	4.5 Technical data	19
	4.6 Noise information	19
	4.7 Rating plates	20

4. Technical data

4.1 Power supply

Electric power supply

Mains voltage:	400 V, 3-phase, 50 Hz
Fuse rating:	At least 32 amps, 63 amps recommended
Generator:	60 kVA recommended
The generator must be earthed when in operation	

Water supply for hydraulic unit, saw head and saw blades

Cooling water:	7 l/min. at 4–6 bar; temp. 20°
----------------	--------------------------------

4.2 Dimensions and weights

D-LP 32 hydraulic unit

L×B×H	790×540×1090 mm
Weight with oil	220 kg

remote control unit D-RC-LP 32

L×B×H	390×180×120 mm
Weight	2.2 kg

DS-TS 32 saw head

L×B×H	510×380×400 mm
Weight	36 kg

4.3 IP protection code

D-LP 32 hydraulic unit:	IP 44
D-RC-LP 32 remote control unit:	IP 65

4.4 Climatic conditions for operation and storage

- The nominal values given in the data for the D-LP 32 /DS-TS 32 hydraulic saw system are applicable at ambient temperatures within the –15°C to +45°C range (hydraulic unit warmed up in advance at temperatures below zero).
- When dry, the units can be stored at temperatures between –15°C and +50°C.

4.5 Technical data

D-LP 32 hydraulic unit

Rated power input at 63 A	43 kW
Rated output	32 kW
Rated voltage	400 V / ~ 50 Hz, 3P+N+PE or 3P+PE
Ground fault circuit breaker (PRCD)	30 mA, in mains supply on site
Max. operating pressure	210 bar
Oil flow rate	30–100 l/min.
Dimensions (LxBxH)	790x540x1090 mm
Weight	220 kg
IP protection code	IP 44
Cooling	Water cooling with 7 l/min. at max. 6 bar and water temperature 20°C

D-RC-LP 32 remote control unit

Control voltage	24 V (DC)
Dimensions (LxBxH)	390x180x120 mm
Weight	2.2 kg
IP protection code	IP 65
Cable length	10 m
Cable length with extension	20 m

DS-TS 32 saw head

Drive	54 ccm hydraulic motor
Dimensions (LxBxH)	510x380x400 mm
Gearing	1 gear
Max. oil flow rate	100 l/min.
Max. operating pressure	200 bar
Hydraulic couplings	Pressure hose (PH) – $\frac{3}{4}$ " Control hose (FH) – $\frac{1}{4}$ "
Operation	With D-RC-LP 32 digital electronic remote control
Saw blade diameter range	800–1600 mm dia.
Wire sawing	500 dia. drive wheel
Weight	36 kg

4.6 Noise information



Equipment:	D-LP 32/DS-TS 32 hydraulic saw system
Typical A-weighted noise level of the equipment: Emission sound pressure level (at a distance of 3 m) as per ISO 11203	90 dB(A)
Sound power level as per ISO 3743-1	103 dB(A)
Noise protection measures are necessary.	

Wear ear protection!

4. Technical data

4.7 Rating plates

HILTI® D-LP32
Reg. Trademark of Hilti Corp. FL-9494 Schaan

Nennleistung : 32kW / S6-60%ED
Nennspannung : 400V 3P+N+PE~50Hz
Nennstrom : 63 A / Iso Kl.F
Oeffluss (Druck) : 0-100 l/min (0-210 bar)
Schutzgrad : IP 44

Made in Liechtenstein 356753

356756			
--------	--	--	--

HILTI® D-RC-LP32
Reg. Trademark of Hilti Corp. FL-9494 Schaan

Nennspannung : 24 VDC
Schutzgrad : IP 65

Made in Liechtenstein 356762

356590			
--------	--	--	--

HILTI® DS-TS32
Reg. Trademark of Hilti Corp. FL-9494 Schaan

Max. Sägeblatt-ø / Saw blade-ø max. 1600 mm / 63 in.

Oeffluss, Oil flow, Débit d' huile : max 100 Ltr/min
Oeldruck, Oilpressure, Pression d' huile : max 200 bar

Made in Liechtenstein 356738

356740	.	.	
--------	---	---	--

Safety precautions		
	5.1 General safety information	22
	5.2 Use of the equipment as directed	23
	5.3 Electrical safety precautions	23
	5.4 Safety precautions during transport	23
	5.5 Safety measures at the danger area	24
	5.6 Preparations	24
	5.7 Safety precautions to be observed when assembling, securing and operating the wall saw.	25
	5.8 Securing the objects being cut and disposal of sawing slurry	25

5. Safety precautions



5.1 General safety information

■ Sawing work influences the statics of the structure. Approval must be obtained from the site engineer or architect prior to carrying out drilling and sawing work.

■ You must be fully aware that working with the D-LP 32 / DS-TS 32 hydraulic saw system always involves a certain element of risk due to wear or damage to parts. Check the condition of the entire system, including accessories, each time before use to ensure it functions correctly.

Wearing parts such as the blade guard holder rubber, end stop, blade mounting screw, flush-cutting blade mounting screws, etc., should be inspected particularly carefully. Check that all parts have been assembled correctly and consider all other factors that could influence operation of the equipment.

Contact your Hilti representative or Hilti service centre if faults or deficiencies are found.

■ Use the hydraulic saw system only when you have read the operating instructions, when you are familiar with the information contained therein and when you have been trained to use the equipment safely by a Hilti specialist. All warnings and safety information must be observed.

■ The area in front of, behind or below the surface where sawing work or drilling work is to be carried out must be secured in such a way that persons or equipment cannot be injured or damaged by falling objects. If necessary, concrete cores or blocks of concrete that have been cut free should be secured to prevent them falling.

■ The operator in charge must be aware of the possible dangers and of his responsibility for safety, both with regard to himself and to others.



■ Read the operating instructions carefully before operating the equipment for the first time and observe all precautions and instructions contained therein.

■ The influences of the environment in which you are working must be taken into account. Do not position the equipment where the hydraulic unit is liable to become very wet. The hydraulic unit must be kept level during operation, i.e. on a horizontal surface. Secure the hydraulic

unit at locations where there may be a risk of it falling (e.g. on scaffolding). The electric extension cable and its plugs and sockets must not be allowed to lie in water. Do not use the equipment in the vicinity of inflammable liquids or gases. Make provision for water removal and disposal.

■ Always keep the operating instructions with the equipment and pass them on to any subsequent user who has been trained in its use.

■ When not in use, store the hydraulic saw system in a locked, dry place out of reach of children.

■ Use the hydraulic saw system only for the applications for which it has been designed.

■ In addition to carrying out the specified care and maintenance, careful cleaning is also a prerequisite for safe, trouble-free operation of the equipment.

■ Always stay alert and carefully observe the progress of your work. Proceed logically and do not use the equipment when you are unable to concentrate on your work.

■ Do not leave tools (e.g. open-end wrenches) in place on the equipment. Check the drive unit to ensure that all tools have been removed before switching on.

■ Keep the working area tidy and well lit. An untidy workplace and inadequate lighting increases the risk of accident.



■ Wear suitable, close-fitting work clothes including a hard hat, protective goggles, protective gloves, safety footwear, ear protectors and a hair net, if you have long hair.



■ Respiratory protection should be worn when working in enclosed or poorly ventilated areas and when dry cutting is being carried out.

■ Keep children and other persons well away from the workplace and allow no-one to touch the wall saw or power cable.

■ **Failure to comply with the warnings and safety information may lead to severe or possibly fatal injury as well as serious damage to the equipment and other property.**

■ Dust from material such as paint containing lead, some wood species, minerals and metal may be harmful. Contact with or inhalation of the dust may cause all-

ergic reactions and/or respiratory diseases to the operator or bystanders.

Certain kinds of dust are classified as carcinogenic such as oak and beech dust especially in conjunction with additives for wood conditioning (chromate, wood preservative). Material containing asbestos must only be treated by specialists.

Where the use of a dust extraction device is possible it shall be used. To achieve a high level of dust collection, use a suitable vacuum cleaner of the type recommended by Hilti for wood dust and/or mineral dust together with this tool. Ensure that the workplace is well ventilated. The use of a dust mask of filter class P2 is recommended. Follow national requirements for the materials you want to work with.

■ **Before beginning work, check the working area (e.g. using a metal detector) to ensure that no concealed electric cables or gas and water pipes are present.** External metal parts of the machine may become live, for example, when an electric cable is damaged accidentally. This presents a serious risk of electric shock.

■ **The machine is not intended for use by children, by debilitated persons or those who have received no instruction or training.**

■ **Children must be instructed not to play with the machine.**

5.2 Use of the equipment as directed

■ The D-LP 32/DS-TS 32 hydraulic saw system has been developed for the technical demolition of steel, concrete, stone or brickwork structures in construction and civil engineering applications. It can be used for wet or dry sawing (the wet sawing technique is normally used). Use extending beyond this is considered to be not as directed and requires to be clarified in advance with the manufacturer.

■ The hydraulic saw system may be operated only by specialists trained in concrete cutting techniques, referred to in the following as “operators”. These persons must be familiar with the content of these operating instructions and must have been trained in their safe application by a Hilti specialist.

■ National regulations and laws, as well as the operating instructions and the safety information applicable to the accessories employed (saw blade, fastening accessories etc.) must be observed.

■ Use only the accessories recommended in these operating instructions. The use of other accessories may result in damage or injury. Use only original Hilti spare parts.

■ Use only saw blades approved for a cutting speed of 63 m/sec.



5.3 Electrical safety precautions

■ Connect the unit only to a power source equipped with an earth conductor and ground fault circuit breaker (PRCD). Check that these items are in perfect working order before operating the equipment.

■ Make sure that the mains voltage corresponds to the specification given on the rating plate.

■ Protect yourself against electric shock, i.e. avoid contact with earthed components such as pipes, radiators and the like.

■ Check the condition of all cables and plugs each time before use.

■ Keep all electric cables, especially their plug connections, in a dry condition. Close the electric sockets by means of the covers supplied when not in use.

■ Use of extension cables: Use only extension cables with adequate conductor cross-section which are approved for the intended field of use. Do not work with extension cables when they are rolled up. This can result in a drop in output at the equipment and may cause the cable to overheat. Replace damaged extension cables.

■ Disconnect the power cable before beginning cleaning and maintenance work or in the event of a lengthy interruption between periods of operation.

■ Any generator used must be earthed when in operation.



5.4 Safety precautions during transport

■ Make sure that the hydraulic saw system cannot move about during transportation.

■ Always avoid adopting a bent-over body position

5. Safety precautions

when carrying heavy items, i.e. keep your back straight when lifting and carrying. Maintain a secure stance, especially when using ladders or when working from scaffolding.

■ Use the handles provided for transportation of the drive unit and control unit. Ensure that the handles are always kept clean and free of grease.

■ If the drive unit and control unit are to be transported by means of a crane, the lifting points provided must be used.

■ Only suitable, conventional site cranes or mobile cranes may be used for lifting.

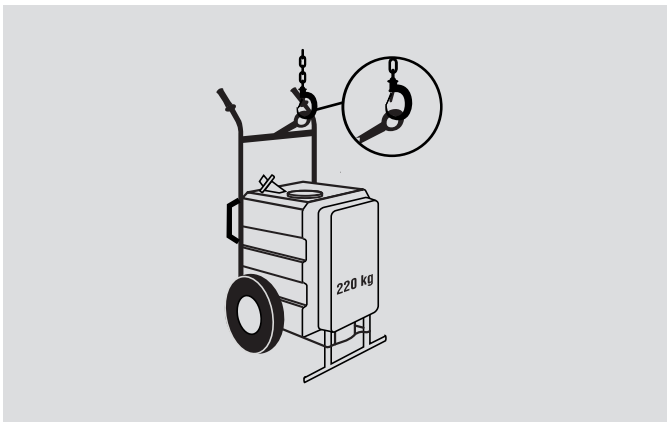

5.5 Safety measures at the danger area

■ Safety measures must be implemented in the area where sawing is taking place to ensure that operators and bystanders cannot be injured or property damaged by debris that may fly off or fall down (broken-off diamond segments, small stones, sawing slurry, etc.) while sawing is in progress. Safety measures must also be implemented in the area not directly visible to the operator, i.e. behind where sawing is taking place.

■ Persons must NEVER enter the danger area (3 meters in all directions from the line of the cut to be made) while the blade drive is switched on.

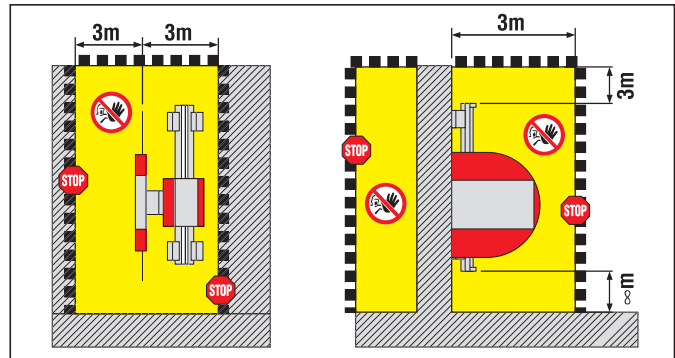
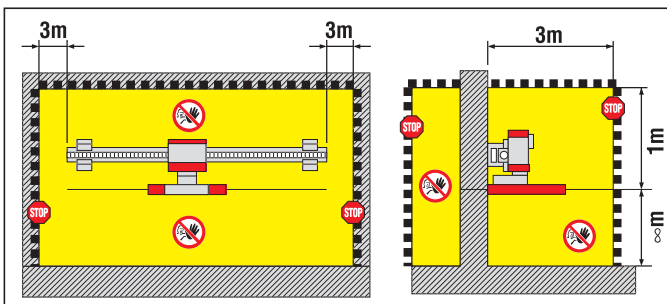

CAUTION

Secure the working area. Ensure that no persons can be injured or property / equipment damaged by falling objects or debris that may fly off during the sawing operation.

1. Approval must be obtained from the site engineer or site management before beginning the sawing work.
2. Find out whether overcutting at corners is permitted. If not, the corresponding corner holes must be planned and drilled first.
3. Check that the area is cordoned off, that supports are in place and warnings to third parties are displayed.

When setting up and operating the saw system and when removing parts that have been cut away, always ensure that no persons are below the area in which you are working. Falling objects could cause serious injury.

The danger area may be entered only when the machine is switched off at the main switch.



5.6 Preparations

■ Keep the working area tidy and always unroll the full length of hoses and cables. Untidiness and bad organisation of the working area can lead to accidents.

■ Make sure that no gas, water, electricity or other supply lines are located in the cutting area. Supply lines located close to the cutting area which could be damaged by falling parts, for instance, must be specially protected and, if necessary, temporarily switched off etc.

■ Ensure that the cooling water used is drained or extracted in a suitably controlled manner. Water that is allowed to drain away or spray around in an uncontrolled manner can lead to damage or accidents. The fact that water could drain away into internal, hidden cavities, e.g. in brickwork or masonry, must also be taken into account.

- Make a careful note of any influence the immediate surroundings may have on operations. Do not use the hydraulic saw system in areas where there is a risk of explosion or in close proximity to combustible materials, fluids or gases. Flying sparks or electrostatic discharge can lead to fires or explosions.
- Do not cut materials which may produce toxic or explosive dust or vapours when cut.
- Do not cut easily combustible aluminium or magnesium alloys.

5.7 Safety precautions to be observed when assembling, securing and operating the wall saw

- Use metal anchors (size M 12) for fastening DS-RF rail supports and DS-RFP angular cutting plates. Secure fastenings of a type suitable for the material being cut must be installed, e.g. Hilti HKD-D, HSA-A, Hilti HIT, HEA / HAS anchors.
- Use only ISO 8.8 grade fastening screws for the rail supports.



- An end stop must always be fitted at the end of the rail to prevent unintentional advance beyond this point (prevents saw coming off the end of the rail).



- The blade guard must always be in place when the saw is in use. NEVER stand in the direction of radial flight of a running saw blade. Special precautions must be taken to secure the danger area when special cutting applications are in progress.
- Always operate the machine from the closed side of the blade guard when corner cuts are made with the blade guard in the partly open position. The operator must take additional precautions (fit a cover, plank of wood, boards etc.) where necessary.
- Never attempt to connect or disconnect hydraulic hoses while the hydraulic unit is running and while the hoses are under pressure.



- Handle the DS-RFP angular cutting plate carefully. There is a risk of pinching your fingers.



- It is essential that the prescribed checks are carried out before beginning sawing (see section 5.5).



- Unless special safety precautions are taken, the D-LP 32/ DS-TS 32 must NOT be operated in environments where there is a risk of explosion.
- The hydraulic unit and the operator with the remote control unit should be positioned as far as possible outside the danger zone. The operator with the remote control unit should remain at a safe location while the saw is in operation.
- Use only adequately dimensioned fastening materials to secure the saw (anchors, screws, etc.). Recommendations can be found in our catalogues and brochures.
- Operate the saw only when the blade guard and rail-end stops have been fitted and secured.
- Observe the recommended cutting speeds and advance pressures while sawing.
- Protective gloves should be worn as the oil and parts of the equipment can become very hot.
- Wear the protective clothing and other items of protective equipment listed in section 5.1.
- Before each cut, check that there is no play between the saw head and the rail and that the eccentric rollers are engaged.
- When additional safety precautions are taken, overhead sawing is also possible. In this case, the blade guard must be equipped with a means of water drainage. Do not stand beneath the saw.



5.8 Securing the objects being cut and disposal of sawing slurry

- Steel wedges and/or supports must be used to pre-

5. Safety precautions

vent uncontrolled movement of parts being cut free in order to avoid injuries and to prevent the saw blade becoming trapped or jammed.

■ Use only approved and appropriately dimensioned means of securing and lifting for the removal and transportation of parts that have been cut free. Such parts may have a weight of many tons.

■ Never loiter in the vicinity of loads suspended by cranes.

■ The point at which the cut is made and any resulting opening must be safely and visibly cordoned off to prevent persons falling and to exclude the risk of damage or injury.

■ Introducing sawing slurry into the drains or sewage system without suitable pre-treatment is problematic from an environmental point of view. Ask the local authority responsible about existing regulations. We recommend the following pre-treatment:

- Collect the sawing slurry (e.g. using an industrial vacuum cleaner)
- Allow the slurry to settle and dispose of the solid portion of the waste at a building waste disposal location (the separation process can be accelerated by adding a flocculent).
- Neutralise the residual water by adding a neutralising agent or dilute it by adding a large quantity of water before allowing it to enter the drainage system.

Before use	6.1 Preparations at the workplace and preparing the saw system	28
	6.2 Setting up the saw system	29
	6.3 D-LP32 hydraulic unit: Connections and preparation for use	34

6. Before use

6.1 Preparations at the workplace and preparing the equipment

6.1.1 Observe the safety precautions listed in section 5.

6.1.2 Power requirements and cooling water

- Check the electric supply fuse rating (63 amps is best and 32 amps is the minimum) and check functionality of the earth connection (this is the responsibility of the site manager).
- Use an electric extension cable with standard Euro plug as per EN CEE 63. Select the cable cross section according to the load it is to carry (amps) and the cable length. Please refer to the following table:

Cable conductor cross section (F)

Current Amps (A)	Hydraulic unit	F mm ² 2,5	F mm ² 4	F mm ² 6	F mm ² 10	F mm ² 16
32	LP32/400V	24	39	59	98	*
40	LP32/400V	20	31	47	78	125
63	LP32/400V	20	30	50	80	80

* maximum cable length in metres

Electric cable

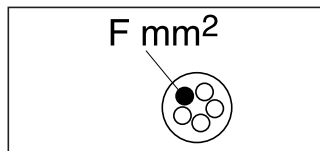

Pin assignment for CEE 63 plug on D-LP 32
LP32, 400 V, 3 P + N + PE

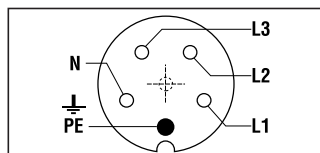

PE = earth
N = neutral

L1 = phase
L2 = phase
L3 = phase

- The CEE 63 plug, male type, complies with the IEC 309-2 standard.
- Ensure that the water supply has a max. pressure of 6 bar and a flow rate of at least 7 l/min. at a temperature of less than 20°C.
- Make suitable arrangements for water removal, depending on the job and situation, e.g. water barriers, wet-type vacuum cleaner, cover with plastic sheets, etc.

6.1.3 Clarify the situation and secure the workplace

- Obtain approval from the site engineer or site management before beginning sawing. Find out whether

overcutting at corners is permitted. If not, the corresponding corner holes must be planned and drilled first.

- Check that the area is cordoned off, that supports are in place and warnings to third parties are displayed.

6.1.4 Planning the cutting sequence, marking the cutting line and fastening points

- The parts to be cut out are usually marked by the client. A rational cutting sequence can be followed when the rail supports are cleverly positioned.
- If necessary, adjust the size and weight of the concrete blocks to the prevailing conditions by making dividing cuts, e.g. in accordance with the work order, the means of handling the blocks, the crane or the maximum floor loading capacity.

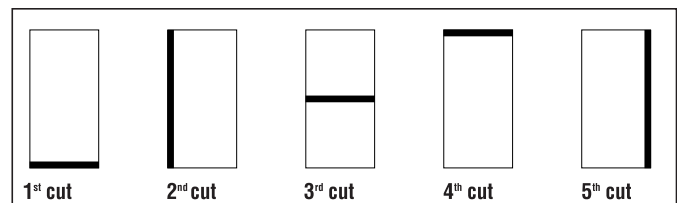

Steel wedges can be used as necessary to secure the cut-out concrete blocks.
Designation: steel wedge

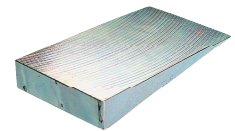

6.1.5 Supporting / securing concrete blocks

Concrete blocks with a weight of several hundred kilograms may be cut out during sawing. Secure the blocks as necessary, before beginning sawing, as shown in the following examples:

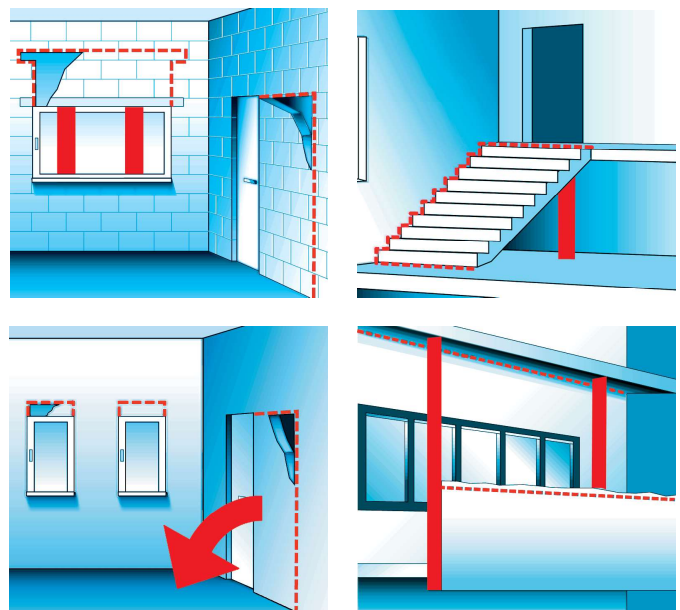

6.2 Setting up the saw system

6.2.1 Securing to the base material

- The saw system can be used efficiently and safely only when anchored rigidly and securely to the base material. We recommend use of Hilti drilling machines and anchor systems.
- The rail supports and angular cutting plates must be secured with anchors suitable for the base material.

WARNING

Use an anchor suitable for the material on which you are working and observe the anchor manufacturer's instructions.

NOTE

Hilti M12 metal expansion anchors are usually suitable for fastening diamond core drilling equipment to uncracked concrete. Under certain conditions it may be necessary to use an alternative fastening method. Please contact Hilti Technical Service if you have any questions about secure fastening.

- When placing the Hilti HKD M12 metal expansion anchor, for example, a minimum distance of 20 cm to the nearest edge must be observed. The dust must be blown out of the holes and the anchors set approx. 5 mm below the surface of the concrete.
- On masonry, etc., for example, Hilti HIT adhesive anchors or through rods may be used.
- On extremely uneven surfaces, suitable shims or packing pieces must be positioned beneath the rail supports where necessary, or the rail support adjustment screws adjusted accordingly.
- The most frequently used anchor on reinforced concrete:

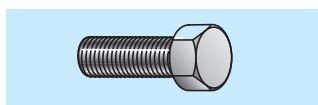
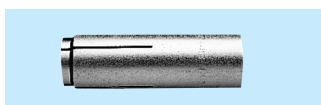
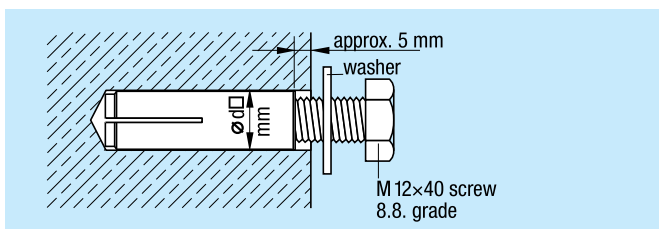

Recommended by Hilti:
HKD-D M12x50, d 16

The use of galvanised screws is recommended.

6.2.2 Positioning the rail supports for standard cuts

DS-TS32 main dimensions and distance from the kerf (mm):

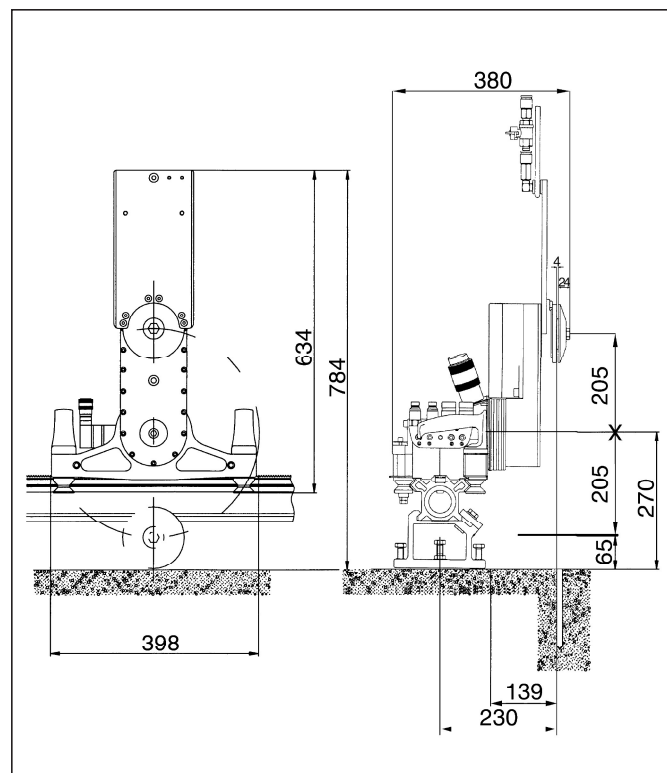

Example: Sawing out a door opening

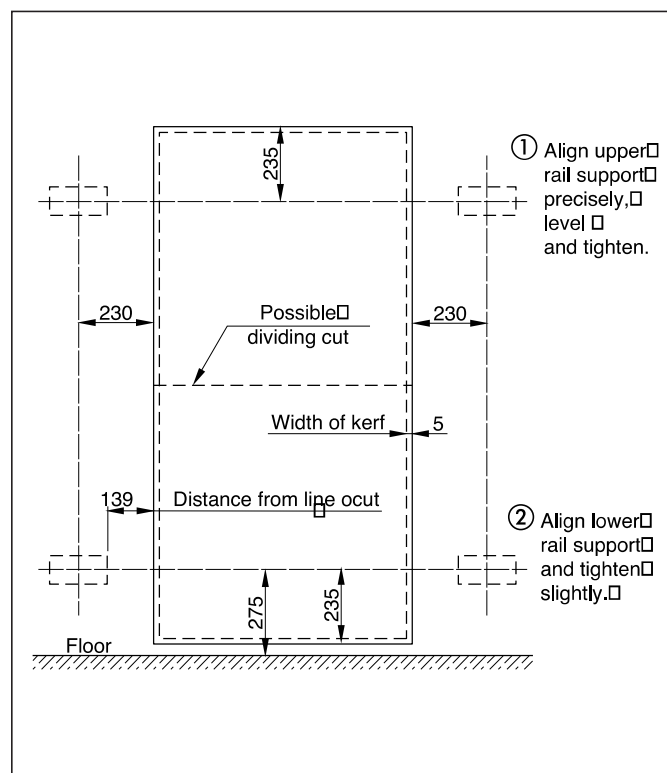

6. Before use

6.2.3 Mounting D-R..L rails, clamping piece and rail extension

- D-R..L rails are available in 50, 100, 150, 200 and 230 cm lengths
- Use the D-CP-M/L clamping piece when the rail is mounted vertically. Attach the clamping piece to the D-R..L rail and hook it into the upper, previously aligned and levelled DS-RF rail support. ❶
- Position the lower end of the rail in the lower rail support (not yet fully tightened), slide up the clamping plate and tighten the M12 screw. Check the distance from the cutting line and alignment of the rail before fully tightening the screw ❷
- When mounting the rails, always position the rail support at right angles to the rail and then tighten all rail fastening screws securely.
- All Hilti D-R..L rails can be extended to form a rigid unit by using a D-C-O-ML double taper and D-EP-ML eccentric pin.
- The recommended distance between rail supports is approx. 1.5 m.
- When a double taper is not available for use, rails can be extended by mounting a rail support at the joint between two rails. In this case, use a DS-ES-L end stop to set the correct distance between rail sections.

- D-R..L rails are also used as the column in the DD-750 HY hydraulic drilling system.
- Fit the end stop after mounting the rail.



D-CO-ML double taper

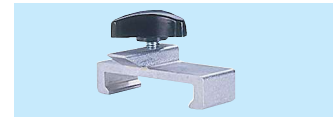

D-CP-ML clamping piece



D-EP-ML eccentric pin

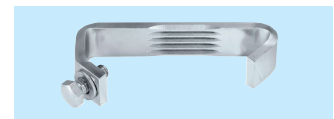

DS-ES-L end stop

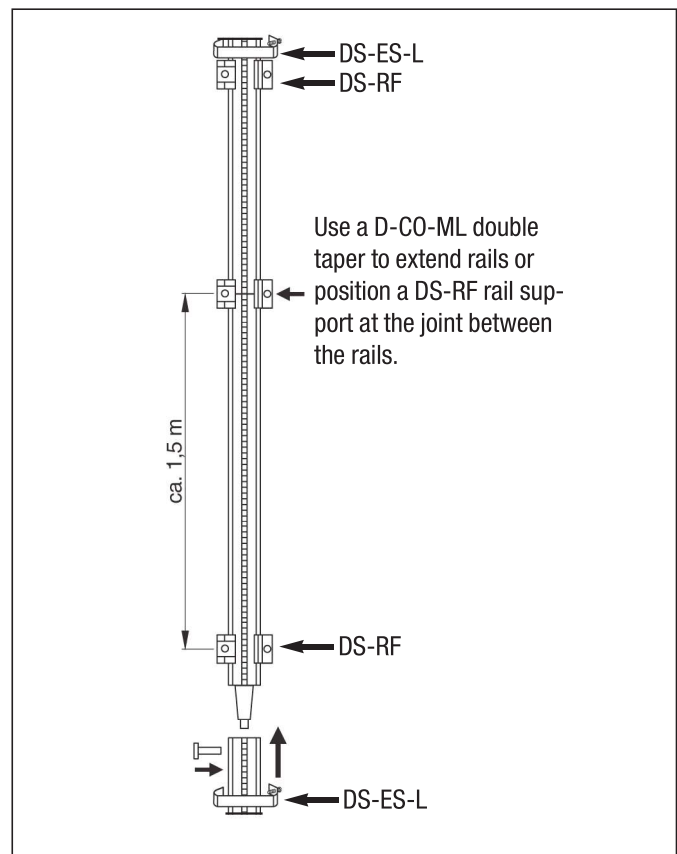
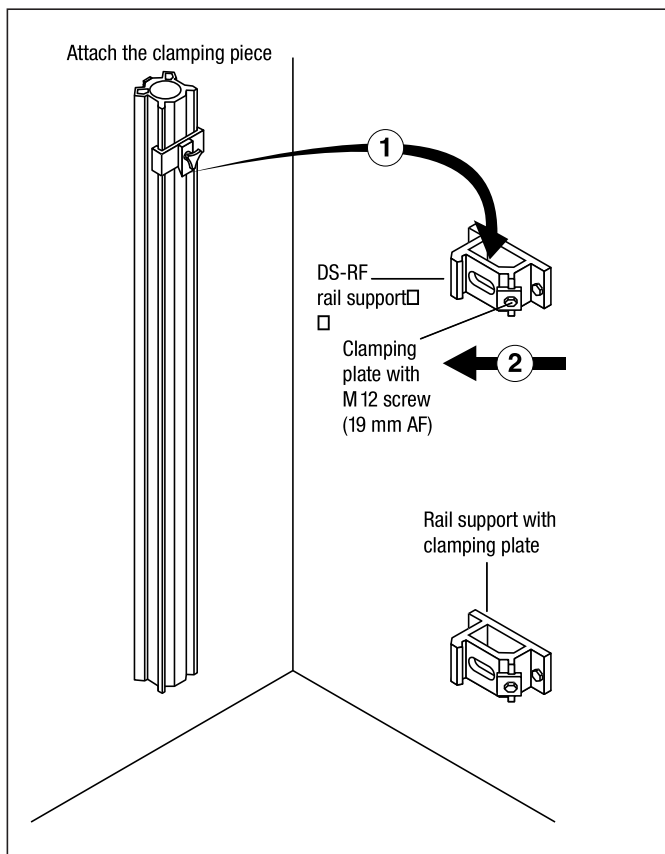

6.2.4 Mounting the DS-TS32 saw head, hydraulic hoses and saw blade

- The pivoting saw arm ① should be in the starting position (pointing vertically upwards). Press the release buttons ③ with the thumbs and pivot the grips ② through approx. 180° outwards towards the saw arm. The cam-action rollers ④ on the saw arm side are now in the open position.
- Position the saw head on the rail (rail already fastened securely), engage the carriage with the teeth on the rack and close the cam-action rollers by pressing the lockbuttons with the thumbs and pivoting the grips into the closed position.
- Connect the D-PH 34 hydraulic hose ⑤ (PH 3/4" pressure hose for the motor) and the D-FH 4/14 hose set (⑥ FH 1/4" control hose) to the saw head.
- Bring the blade guard holder ⑦ into a suitable position on the saw arm. Use the hex. wrench (10 mm AF) to tighten the hex. screw in the centre of the saw arm securely before mounting the saw blade. The holder and the blade guard then remain in the desired position during the entire sawing procedure
- The grips ③ are used for carrying the saw head.

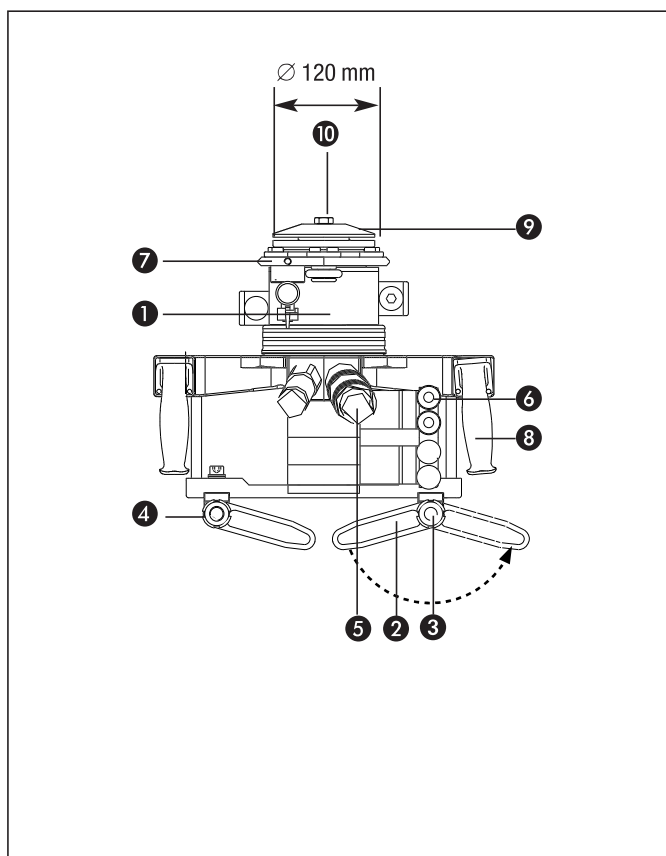

Mounting the saw blade

- Select the saw blade (diameter, Hilti type CS-H, CM-H or CH-H) depending on the concrete, the job to be done and the cutting sequence using saw blades of different diameters.
- Position the saw blade, observing the correct direction of rotation, on the drive hub of the saw arm.
- Fit the special blade flange ⑨ and the special screw ⑩ M12x25 (10.9 grade).
- Rotate the blade slightly so that the countersunk holes for fastening the blade for flush cutting are positioned BESIDE the 6 water grooves.
- Use the 19 mm AF ring wrench to tighten the special M12 screw securely ⑩.

6.2.5 Instructions for handling hydraulic hoses and hydraulic couplings

- Always clean the couplings with a cloth before connecting. Turn the securing ring on the coupling after the click is heard.
- To ensure reliable operation and extend the life of the entire system, it is important that all hydraulic couplings are cleaned daily.
- Do not leave hydraulic couplings lying in the dirt and do not knock them against concrete surfaces. Avoid dragging hydraulic hoses over sharp edges.
- After transporting all modules to the workplace, the hydraulic unit should be positioned correctly and the hydraulic hoses connected to the unit immediately. This prevents pressure building up in the hoses even when directly exposed to the heat of the sun.
- Should the hydraulic hoses prove difficult or impossible to connect even after relieving pressure in the system by operating all valves (controls), the D-PRT pressure release valve can be used to release excess pressure from the hoses. The small quantity of escaping oil should be caught in a cloth.
- Before disconnecting couplings, turn the locking sleeve until it engages in the "open" position.

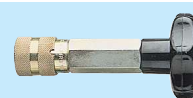

D-PRT FH 1/4" pressure release valve



D-PRT PH 3/4" pressure release valve

6. Before use

6.2.6 Blade guard

- Always ensure that the DS-BG blade guard is in place when the saw is in operation.
- The blade guard is in two sections to permit cutting into corners.
- Thanks to its symmetrical design, the blade guard can simply be turned to permit cutting into a corner to the left or right (or upwards and downwards) without removing the blade from the kerf.
- Use the 10 mm AF hex. wrench to tighten the blade guard holder. The blade guard then always remains in the same position.
- Use the DS-BGF blade guard (open on one side) for flush cutting.

DS-BG



DS-BGF



6.2.7 Using the DS-RFP angular cutting plate

- The angular cutting plate is used for sawing on stairs, in tunnels and for cutting at an angle of up to 45°.
 - Align the equipment by using a protractor to measure the angle at the blade when mounted on the saw.
 - Due to the angle of the blade, cutting depth is reduced. The blade is also subjected to additional bending loads. Please refer to the following table for setting-up dimensions and cutting depths.
- IMPORTANT:** When making angular cuts, make a shallow guide cut and begin cutting gently!

DS-RFP

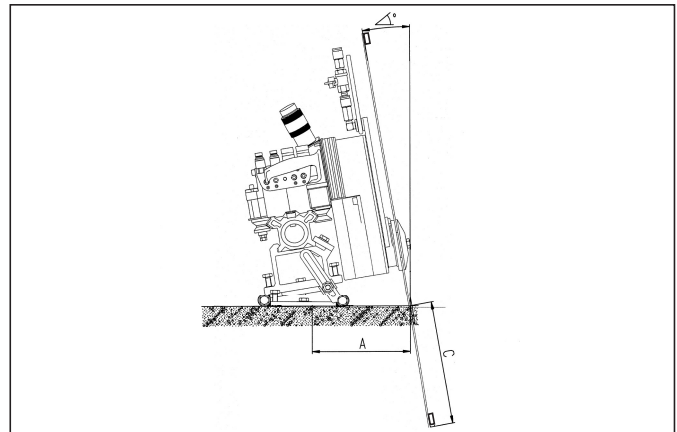
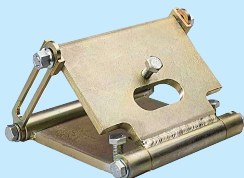

Angle of cut	10°	20°	30°	40°	45°
Diameter mm)	900	900	900	900	900
C (cm)	30	24	18	8	3
A (cm)	24	26	29	34	38

6.2.8 Flush cutting using the DS-FCA-110 flush-cutting flange

- As for standard sawing applications, the blade can be fitted after the saw has been mounted on the rail. (Old method: The saw and the fitted saw blade had to be lifted together onto the rail and the saw blade guided into the kerf.)
- The Hilti saw system can be preassembled and positioned precisely, to the millimetre.
- The electric remote control system permits the saw arm to be pivoted effortlessly to the height of the saw blade mounting hole.
- Spindle speeds and the sawing procedure are as for standard applications.

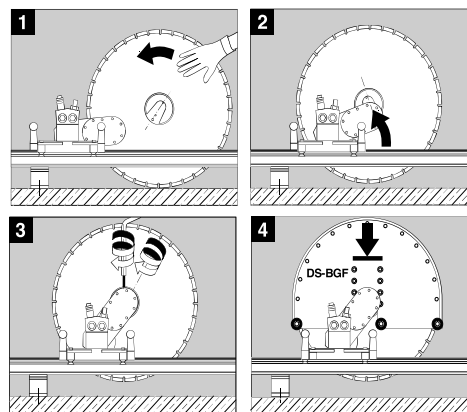

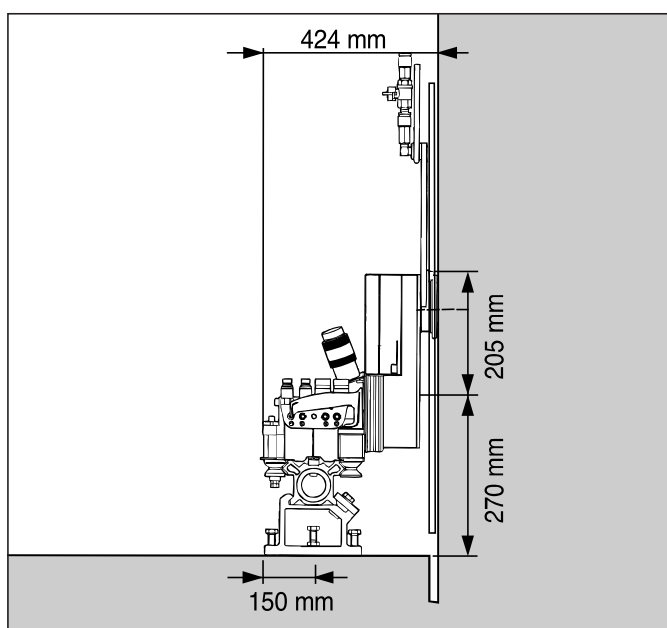
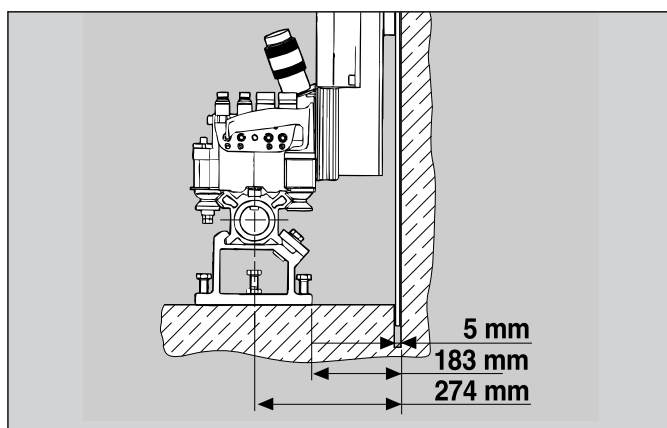

6.2.9 D-LP 32/DS-TS 32 tool set

- The tool set contains all the tools necessary for installing and mounting the saw and includes safety-relevant parts, fastening screws, nuts etc.
- Use of the Hilti tool set ensures that the equipment can be operated correctly and safely.
- All tools and parts contained in this set, their functions and item nos. for reordering, are described in the manual included with the set.



D-LP 32/DS-TS 32 tool set

6.2.10 DS-TS 32 hose and cable connections

- Two PH^{3/4} hoses and one FH^{1/4} hose set are used to connect the saw head to the hydraulic unit.
- All functions can be controlled only by way of the D-RC-LP 32 electric remote control unit.
- The hydraulic hoses and remote control cable have a standard length of 10 metres. This length can be extended, but a drop in performance must then be expected.

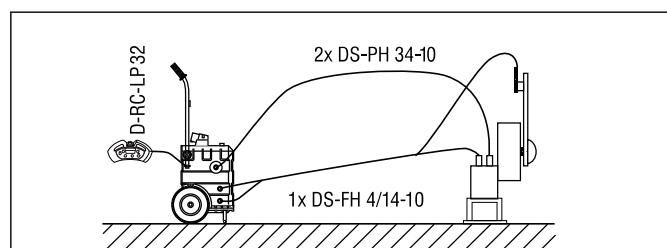

6.2.11 Using other hydraulic units to power the DS-TS 32 saw

- Damage to the DS-TS 32 resulting from use of a hydraulic unit other than the D-LP 32 or D-LP 30 to power the system is not covered by the warranty provided by the Hilti Corporation.
- Should you decide to operate the saw, at your own risk, with a hydraulic unit of a type not specified by Hilti, the hydraulic unit used must fulfil the following conditions:
 - Oil flow rate 80–100 l/min.
 - Maximum operating pressure 190 bar.
 - Modifications to the DS-TS 32 hydraulic couplings are NOT permitted (see illustration showing direction of oil flow).
- The user carries the responsibility for ensuring that the control system employed functions correctly.

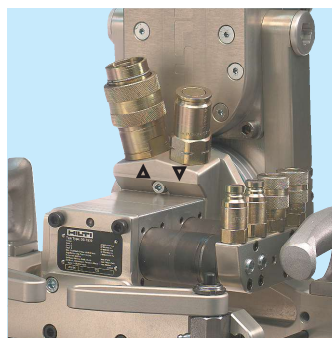

- ▽ Direction of oil flow (pressure hose)
- △ Direction of oil flow (return hose)

6. Before use

6.3 D-LP 32 hydraulic unit Connections and preparation for use



- 1** 3-phase 400 V mains supply with appropriate fuse rating. The switching control sets the correct direction of motor rotation automatically. Standard plug as per EN CEE 63.
- 2** The unit employs a star / delta switching system (Y- Δ). Starting up takes only a few seconds (max. 5 sec.).
- 3** Use an extension cable with adequate cross section. The unit will not start if the voltage supply is too low or if one of the phases is too weak.
- 4** The water supply is always connected to the lower coupling on the hydraulic unit. Water pressure max. 6 bar, flow rate at least 7 l/min. at temperature below $\leq 20^{\circ}\text{C}$. We recommend that the jobsite water supply connection is equipped with a non-return valve, in accordance with national regulations.

- 5** Socket for D-RC-LP 32 remote control unit.
- 6** Keep the hydraulic couplings clean. When connecting the hoses, turn the securing ring after the coupling engages with an audible "click".
- 7** D-RC-LP 32 remote control unit.
- 8** Water system connection (FH 1/4" hose set to saw head).
- 9** Disconnect the water supply hose after finishing work. Water then drains from the hydraulic unit (oil cooler) automatically (also disconnect the water system hose).
- 10** Cap / oil filler neck
- 11** Oil filter cover
- 12** Guidelines for use (sticker)
- 13** Emergency OFF switch
- 14** 230 V socket (max. 10 amps) for light-duty rotary hammer drills and lights, etc.
- 15** Rating plate
- 16** On / off control switch
- 17** Overload reset button (230 V socket)
- 18** Lifting point for transport by crane



Operation	7.1 Checks before beginning sawing	36
	7.2 The sawing procedure and saw operation	37
	7.3 Guidelines and guide values	38
	7.4 Dismantling the saw system	41

7. Operation

7.1 Checks before beginning sawing

- On-site preparations must be completed (supports, water collection, etc.).
- The hydraulic unit must be positioned outside the danger zones. The areas in front of and behind the component where sawing is to take place are danger zones and must be secured and cordoned off. No persons may remain in a danger zone.
- The power cable and water supply must be connected. The power supply must be earthed and equipped with a ground fault interrupter (PRCD). The water supply must be within the permitted pressure range.
- The rail supports and rails must be aligned and fastened correctly, with all screws and nuts tightened securely.
- The saw head must be mounted without play and the cam-action rollers engaged.
- The hydraulic hoses and water hoses must be laid out, connected correctly and the locking sleeves engaged.
- The saw blade must be mounted in the correct direction of rotation and the central screw at the saw blade flange (or six M10 countersunk screws) tightened securely.
- The blade guard and end stop must be fitted securely.
- The remote control unit, power supply cable and water supply hose must be connected.
- The emergency OFF buttons on the hydraulic unit and remote control unit must be disengaged (pulled out).
- All control knobs on the remote control unit and hydraulic unit must be in the "off" or, respectively, (I) position or the "neutral / zero" position.
- The operator should carry the remote control unit (using the shoulder strap).
- The safety precautions must be observed.

7.2 The sawing procedure and saw operation

Please refer to the D-LP 32 hydraulic unit application guidelines sticker, section 2.3.2, page 9.

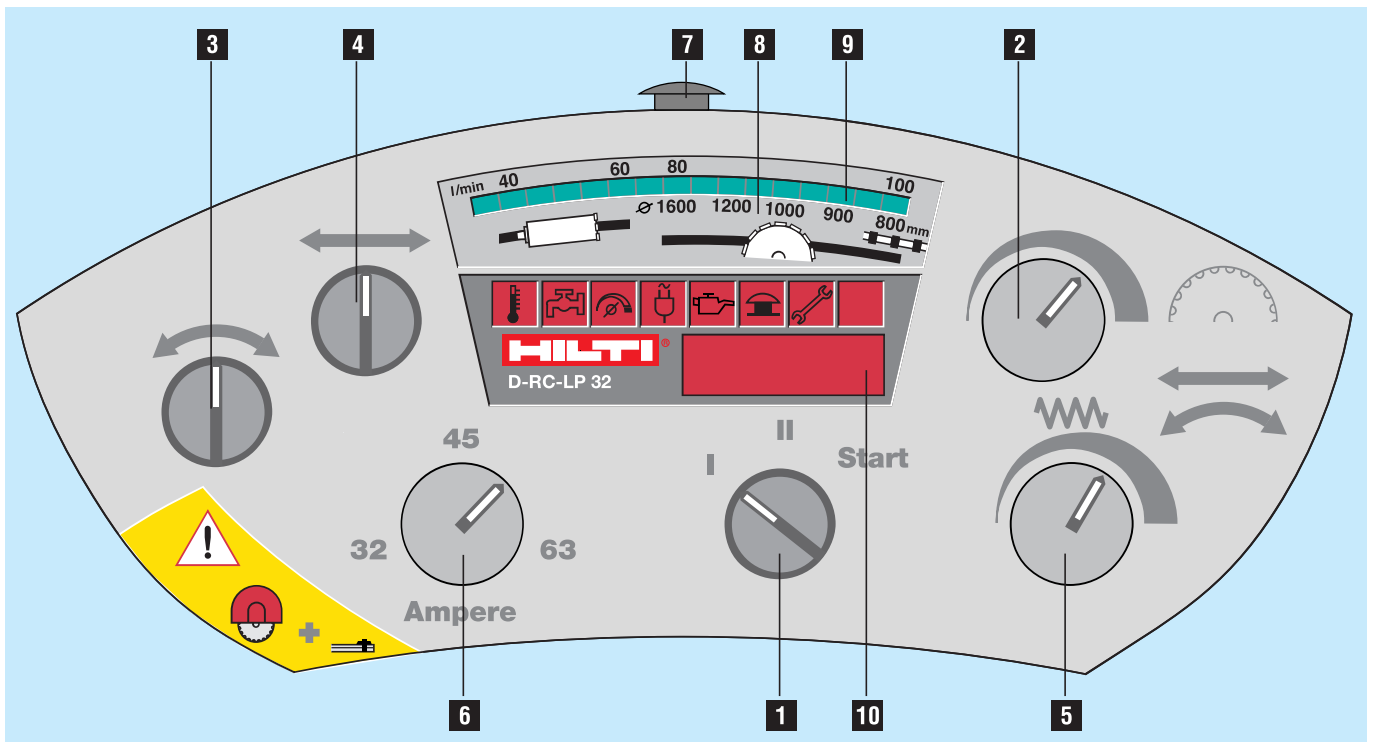

- 1 Open the water valve at the hydraulic unit (flow rate at least 7 l/min., pressure max. 6 bar).
- 2 Set the control switch on the hydraulic unit to the "on" (I) position.
- 3 Turn the current control knob **6** to the desired setting: depending on the power supply available, usually between 32 and 63 amps (maximum power at 63 amps, reduced power at 32 amps).
- 4 Turn knob **1** and then back to position "II". The star (Y) - delta (Δ) motor start-up procedure takes approx. five seconds. Do not manipulate any other controls until the Y-Δ start-up switching sequence is heard to be completed.
- 5 Use the direction control knobs **3**, **4** and the speed control knob **5** to bring the saw head to the starting position and then return the switches to the "neutral/0" position
- 6 Control knob **2** should then be used to set the desired speed (according to blade diameter) **8** or, respectively, the oil flow rate **9**. The display **10** indicates the current operating pressure (bar).
- 7 Using control knobs **3** and **5**, pivot the saw arm / blade until the desired cutting depth is reached and then return the knobs to the "neutral/0" position. Guideline: Please refer to the sticker on the rear of the D-RC-LP 32 remote control unit for cutting depths, guide cuts and cutting sequence.
- 8 Use knob **4** to select sawing direction and set the speed control knob **5** to maximum. Optimise power output by adjusting the current control knob **6**. Make the guide cut with a pressure of max. 110 bar.
- 9 Repeat step number 7 until the desired depth of cut is reached.
- 10 After reaching the final depth, use knobs **3** and **5** to move the saw arm into the 90° position (away from the rail) and then use knobs **4** and **5** to move the saw head to the desired position on the rail. Turn the speed control knob **2** (oil flow rate) back to zero and switch off the drive with switch **1** (the saw blade stops rotating). Check again that all control knobs are in the "neutral/0" position. Finally, press in the emergency OFF button **7** on the remote control unit.
- 11 Close the water valve on the hydraulic unit.
- 12 Switch off the hydraulic unit.



Press the emergency OFF button in the event of encountering a critical or dangerous situation while sawing!

7. Operation

7.3 Guidelines and guide values

7.3.1 Sawing guidelines

Please refer to the sticker on the rear of the D-RC-LP32 remote control unit.

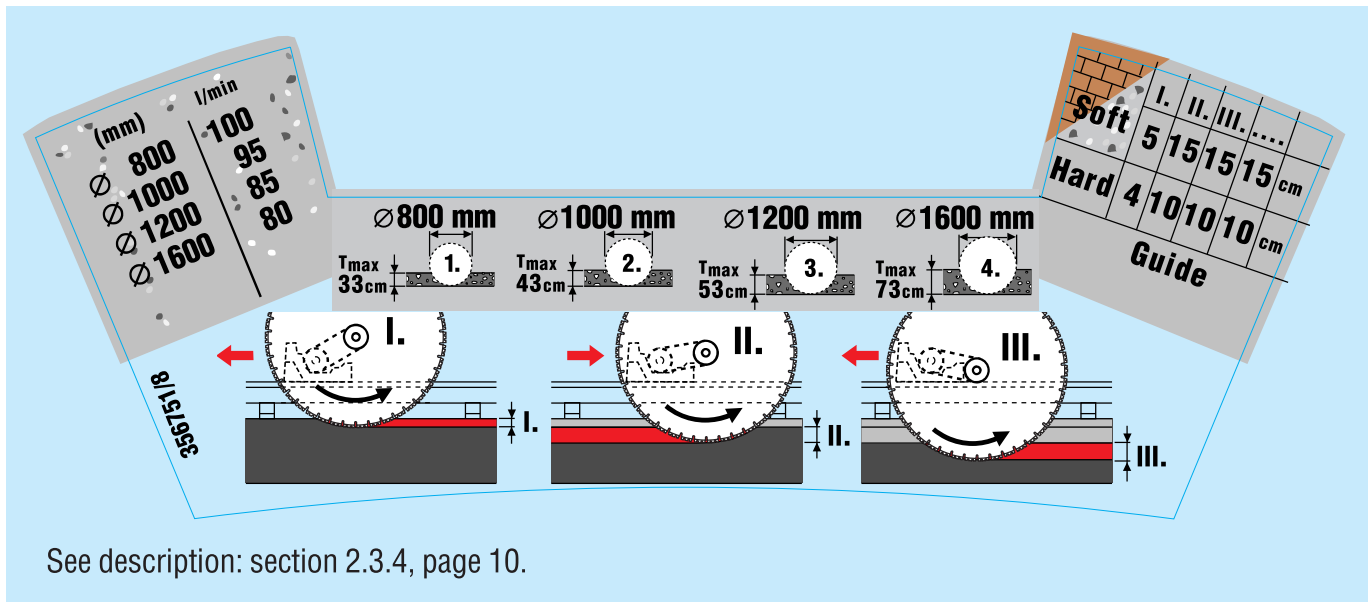

See description: section 2.3.4, page 10.

The guide cut

The initial cut, known as the guide cut, must always be made with the saw arm in the trailing position (see illustration "Sawing guidelines"). Depending on the base material (hard, soft or masonry), the guide cut may be made to a depth of between 4 and 5 cm. For the guide cut, use a pressure of only up to 110 bar. This will prevent the blade from wandering and ensure a straight cut.

Subsequent cuts

On completion of the guide cut, subsequent cuts can be made with the saw arm in the trailing or leading position. The depth of cut, on the other hand, depends greatly on the material and can be between 10 and 15 cm (see illustration "Sawing guidelines", steps II., III. and subsequent steps). These cuts should be made at full power: 110–190 bar.

Ending the sawing procedure

- When the concrete has been cut through, the blade should be lifted out of the cut while still rotating. Switch off the drive and water supply and move the saw head to a suitable position on the rail.
- All knobs on the remote control unit should be returned to the neutral position and the hydraulic unit switched off by turning the starting switch to OFF (position I).
- Set the control switch on the hydraulic unit to the OFF position (0).
- If the hydraulic unit was switched off by way of the emergency OFF button, the control switch on the hydraulic unit must then also be returned to the OFF (0) position.

7.3.2 Application guide values for the D-LP 32/DS-TS 32, D-LP 32/DS-TS 32/WSS 30 and D-LP 32/DD-750 HY hydraulic sawing / coring systems

1. Sawing: D-LP 32/DS-TS 32

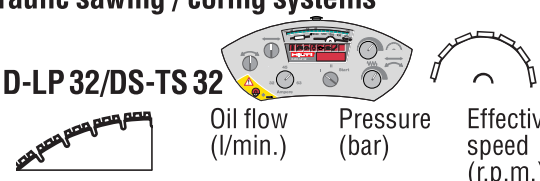

Saw blade dia. (mm)	Oil flow (l/min.)	Pressure (bar)	Effective speed (r.p.m.)	Advance speed	Effective cutting speed (m/sec.)	Amps (A)
800*	100	150	820	Maximum	34	63
900	100	150	820	Maximum	38	63
1000	95	160	720	Maximum	38	63
1200	85	170	580	Maximum	36	55–63
1500	80	190	450	Maximum	37	55–63
1600	80	190	450	Maximum	38	55–63

* Applies also to the D-LP32/TS-PS30 plunge saw, 600–750 mm

2. Wire sawing: D-LP 32/DS-TS 32/WSS 30



Drive wheel dia. (mm)	Oil flow (l/min.)	Pressure (bar)	Effective speed (r.p.m.)	Advance speed	Effective cutting speed (m/sec.)	Amps (A)
500	100	120–140	820	Maximum	21.5	45–50

3. Drilling: D-LP 32/DD-750 HY

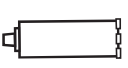

Motor: 20 cm ³ 4 gears	Oil flow (l/min.) (maximum)	Pressure (bar)	Effective speed (r.p.m.)	Advance speed	Effective cutting speed (m/sec.)	Amps (A)
	60	120	480	Manual / automatic hydraulic advance	5	32–45

4. Water supply for drive unit, saw head and saw blades

Cooling water flow rate relative to temperature

20° C	7 l/min.
30° C	8.4 l/min.
40° C	12 l/min.

7. Operation

7.3.3 Saw blade diameters and cutting depths for the DS-TS 32, DS-TS 30 and DS-TS 22/C saw heads

Cutting depths T (cm)

Saw blade diameter	DS-TS 22/C 2 gears	T (cm)	DS-TS 30 2 gears	T (cm)	DS-TS 32 1 gear	T (cm)
500 mm dia.*			⊗	× m	⊗	
600 mm dia.	●	23	○	23		
700 mm dia.	●	28	○	28		
750 mm dia.	●	31	○	31		
800 mm dia.	●*	33	●	33	●	33
900 mm dia.	●	38	●*	38	●*	38
1000 mm dia.	●	43	●	43	●	43
1200 mm dia.	●	53	●	53	●	53
1500 mm dia.			●	68	●	68
1600 mm dia.			●	73	●	73

* Largest initial diameter, ● main application, ○ possible application

⊗ 500 mm dia. drive pulley for the Hilti DS-WSS30 wire saw system, unlimited cutting depth × metres (m)

7.3.4 Remaining distances for the DS-TS32/30 saw heads

DS-TS 32 remaining distances

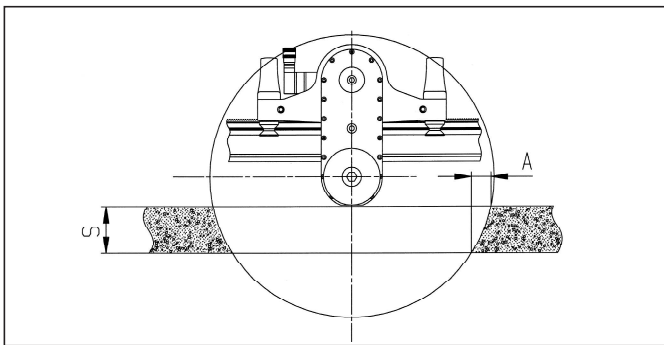

Remaining distance A (cm)

S (cm)	A 800 mm dia.	A 900 mm dia.	A 1000 mm dia.	A 1200 mm dia.	A 1500 mm dia.	A 1600 mm dia.
20	9	8	7	6	5	4
30	23	18	15	12	9	8
40			31	22	16	15
50				39	25	23
60					40	35
70						56

DS-TS 32 remaining distances

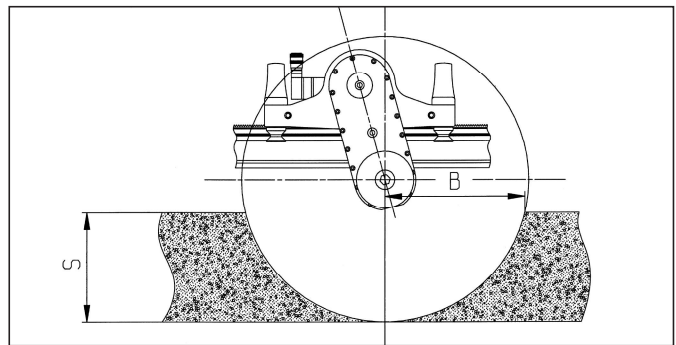





Remaining distance B in (cm)

S (cm)	B 800 mm dia.	B 900 mm dia.	B 1000 mm dia.	B 1200 mm dia.	B 1500 mm dia.	B 1600 mm dia.
20	35	37	40	45	51	53
30	39	42	46	52	60	62
40			49	56	66	69
50				59	71	74
60					73	77
70						79

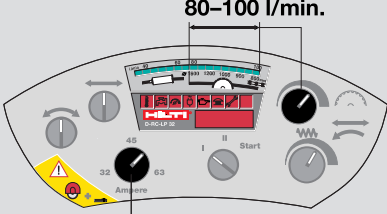
7.3.5 Operating the D-LP 32 with 2-speed gear DS-TS 30 (previous model), selecting the gear, guide values, sawing procedure, saw blades for the 2-speed gear D-LP 32/DS-TS 30 hydraulic saw system

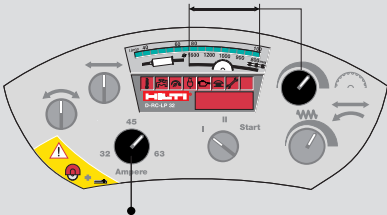
Optimum saw blade cutting speed (peripheral speed): A guide value of approx. 40 m/sec. is recommended by most saw blade manufacturers, including Hilti. Depending on the situation (concrete quality, aggregates, steel content, etc.), speeds of between 30 and 50 m/sec. can be used.

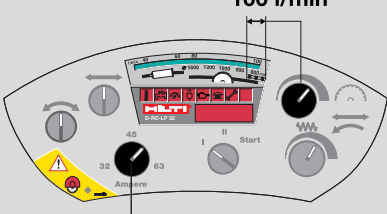
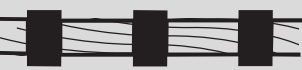
 Guidelines for D-LP 32 with 2-speed gear DS-TS 30										
 <p>80–100 l/min. 32–63 Ampere</p>	<p>D-LP32/DS-TS 30 in 1st gear</p> 	<p>1st gear: 800–1600 dia. All settings same as for D-LP32/DS-TS32</p> <table border="1"> <tr> <th colspan="2">1st gear: 700–750 dia.</th> </tr> <tr> <th>Actual dia.</th> <th>Diameter settings on remote control unit</th> </tr> <tr> <td>700</td> <td>Corresponds to 800 dia.</td> </tr> <tr> <td>750</td> <td>Corresponds to 800 dia.</td> </tr> </table>	1st gear: 700–750 dia.		Actual dia.	Diameter settings on remote control unit	700	Corresponds to 800 dia.	750	Corresponds to 800 dia.
1st gear: 700–750 dia.										
Actual dia.	Diameter settings on remote control unit									
700	Corresponds to 800 dia.									
750	Corresponds to 800 dia.									
 <p>80–100 l/min. 32–63 Ampere</p>	<p>D-LP32/DS-TS30 in 2nd gear</p> 	<p>2nd gear: 600 dia.</p> <table border="1"> <tr> <th>Actual dia.</th> <th>Diameter settings on remote control unit</th> </tr> <tr> <td>600</td> <td>Corresponds to 1600 dia.</td> </tr> </table>	Actual dia.	Diameter settings on remote control unit	600	Corresponds to 1600 dia.				
Actual dia.	Diameter settings on remote control unit									
600	Corresponds to 1600 dia.									
 <p>100 l/min 45–50 Ampere</p>	<p>D-LP32/DS-TS30/WSS30 in 1st gear</p> 	<p>1st gear: 500 dia. drive wheel</p> <p>All settings same as for D-LP32/DS-TS32</p>								

7.4 Dismantling the saw system

- Secure the block of concrete you have cut. Use steel wedges when necessary.
- Clean the equipment by spraying with water. Dry the parts with a cloth.
- Remove the blade guard, blade and other modules (following assembly instructions but in reverse order).
- Secure the concrete block(s) or withdraw them carefully from the hole and make arrangements for their transport.
- Cordon off the opening so that it presents no hazard to third parties.



Care and maintenance	8.1 Cleaning the equipment	44
	8.2 Maintenance of the D-LP 32 hydraulic unit	44
	8.3 Maintenance of the DS-TS 32 saw head	44
	8.4 Maintenance of the other saw modules	44
	8.5 Service and repair	44

8. Care and maintenance

CAUTION

Disconnect the supply cord plug from the power outlet.

CAUTION

Keep the machine, especially its grip surfaces, clean and free from oil and grease. Do not use cleaning agents which contain silicone.

8.1 Cleaning the equipment

- We recommend that the most important parts of the saw system are cleaned quickly between each saw cut. Simply use the water hose to wash down the saw head, rails, blade guard and saw blades.



- All switches and controls must be set to the "off" or neutral positions and the power supply cable unplugged before beginning thorough daily cleaning..
- Immediately after finishing work each day, use the water hose and a brush to wash down the entire set of equipment thoroughly, paying particular attention to the parts mentioned above. Cleaning should be planned as a part of the working procedure. This will ensure that the equipment can be operated efficiently each day.

Cleaning with high-pressure or steam cleaning systems

If a cleaning system of this kind is used to clean the saw head, do not direct the jet into openings or at seals.

8.2 Maintenance of the D-LP 32 hydraulic unit

- Check the oil level of the hydraulic unit at weekly intervals and top up with hydraulic oil of the type HVLP 46 when necessary.
- Change the oil and filter when the service indicator lights up (after approx. 200 operating hours) or once a year, i.e. when the unit is brought to Hilti for servicing (oil capacity of D-LP 32 = 35 litres).
- Should the unit seem to lack power, it can be checked on the spot by a Hilti specialist if necessary.
- Do NOT use a steam cleaning system or water jet to wash down the hydraulic unit.
- **Operation in winter or at low temperatures:** When cold, the hydraulic unit should be allowed to run for a few minutes, with water flowing, until it has warmed up.
- Do not operate the hydraulic unit without cooling water

connected. Always keep the water running when operating at temperatures below zero. Disconnect the water supply to the hydraulic unit and the water system hose when work is finished. The hydraulic unit then drains itself automatically. **Use only water hose couplings of the free-flow type** for the water supply to the hydraulic unit.

- If an electric generator is used to power the D-LP 32 hydraulic unit, we recommend an output of at least 60 kVA. The generator must be earthed.

8.3 Maintenance of the DS-TS 32 saw head

- The saw head basically requires no maintenance. (Exception: Lubrication of the cam-action roller bearings at the grease nipples. The cam-action levers must be in the open or disengaged position when greasing.) We recommend annual servicing.
- The hydraulic couplings should be cleaned daily and checked to ensure ease of operation.
- The guide rollers and cam-action rollers should be kept clean and lubricated with Hilti oil spray.
- Check occasionally to ensure there is no play between the carriage and the rail and adjust correctly if necessary.

8.4 Maintenance of the other saw system modules

- The D-R..L rails have a transparent anodised finish and can be washed very easily. The internal taper on the rails should be cleaned particularly carefully with a cloth and then lubricated with Hilti oil spray.
- The other modules such as the blade guard, rail supports, etc., basically require no maintenance. Nevertheless, we recommend immediate cleaning each time after use.
- The hydraulic hoses should be cleaned daily, paying particular attention to the couplings to ensure ease of operation.

8.5 Service and repair

- Malfunctions are unlikely when the equipment is kept clean and lubricated. Lack of cleaning and incorrect operation may lead to malfunctions.
- Additional parts (spare parts) are available from Hilti service when required and, under normal circumstances, can be fitted on site by the operator himself, by a Hilti specialist or Hilti repair mechanic.

Troubleshooting	9.1 Faults indicated by the D-RC-LP 32 remote control unit	46
	9.2 Error messages – „ER“	47
	9.3 Other malfunctions, faults in the hydraulic unit	48
	9.4 The hydraulic unit or saw system overheats / lacks power	49

9. Troubleshooting

9.1 Faults indicated by the D-RC-LP 32 remote control unit







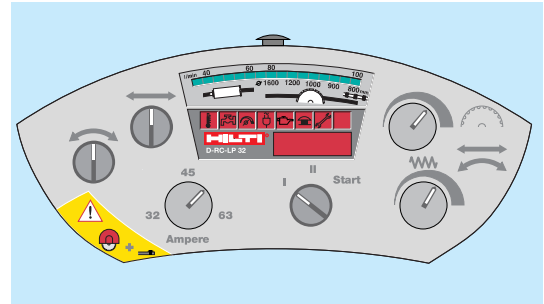



– The most important faults are shown on the remote control unit display panel.

WARNING

Do not operate the equipment when parts of it are damaged or when the operating controls do not function faultlessly. The hydraulic unit should be repaired at a Hilti service centre if found to be faulty.



Fault checklist and solutions

Problem	Symbol on remote control unit	Possible cause	Action to be taken
Emergency OFF lights. Motor doesn't start		Emergency OFF button pressed in	<ul style="list-style-type: none"> – Disengage emergency OFF button on RC-LP 32 remote control unit. – Disengage emergency OFF button on LP 32 unit.
Oil level. Unit switches off.		Oil level in hydraulic unit too low	<ul style="list-style-type: none"> – Top up oil (type HVLP 46) and check oil level at sight glass.
Power supply warning lamp lights. Motor switches off.		– Mains voltage fault	<ul style="list-style-type: none"> – Site power supply should be checked by the site electrician.
Power supply warning lamp blinks slowly. Motor runs again.		<ul style="list-style-type: none"> – Failure of one phase – Extension cable too long, with inadequate conductor cross section – Mains voltage fault 	<ul style="list-style-type: none"> – Check the mains fuse. – Set current control knob (amps) slightly lower. – Use extension cable with suitable cross section (see table, page 28).
Zero position warning lights up.		The corresponding speed control knob is not set to the zero position.	<ul style="list-style-type: none"> – First, set the speed control knob and all knobs on the remote control unit, with the exception of the current control knob (amps), to the zero or neutral position.
Water cooling warning lamp lights, 1 st advance warning		– Inadequate system cooling, i.e. too little water or water too warm	<ul style="list-style-type: none"> – Increase cooling water flow rate, see «cooling» page 39. – Cooling water temperature: 20°C – Use Y-piece with water valves: more water at the hydraulic unit, less at the saw head.
Water cooling warning lamp blinks slowly 2 nd advance warning		<ul style="list-style-type: none"> – Machine is too warm – Inadequate cooling: too little water or water too warm 	<ul style="list-style-type: none"> – The operator must react quickly, taking the action described above, otherwise the hydraulic unit will switch itself off.
Water cooling warning lamp blinks rapidly and oil lamp lights simultaneously.	 	<ul style="list-style-type: none"> – The machine has overheated. – The machine has switched itself off. 	<ul style="list-style-type: none"> – Set control switch on hydraulic unit to «OFF» (O) and then to «ON» (I) again. – Allow the hydraulic unit to run again with maximum cooling water until all warning lamps extinguish. – Normal operation may continue when the warning lamps have extinguished. – Note: If, in this situation, the machine is not cooled adequately, it will switch itself off again and then cannot be restarted for a period of up to two hours.
Although the control switch on the hydraulic unit is in the «ON» (I) position, no lamps light on the remote control unit.		– Fault in at least two or possibly all of the phases in the mains supply	<ul style="list-style-type: none"> – Check the mains fuses at the distribution box / switch on. – The site power supply should be checked by the site electrician. – Check extension cables and plugs / sockets for faults, fix loose contacts.
Service indicator lights		– After 200 operating hours	<ul style="list-style-type: none"> – Return the unit to Hilti for servicing (inspection and oil change)

9.2 Error messages – "ER"

The following error messages are shown on the operating hours display on the RC-LP 32 remote control unit:

Remote control unit errors	Possible cause	Action to be taken
Er00	RC-TS 5-E is connected instead of RC-LP32 remote control unit	Connect RC-LP32
Er01	No communication between the LP32 and RC-LP32	Contact Hilti service
Er02	No communication between the LP32 and RC-LP32	Contact Hilti service
Er03	Supply voltage from D-LP 32 hydraulic unit to remote control unit is less than 22 volts.	Contact Hilti service
Hydraulic unit errors	Possible cause	Action to be taken
Er11	Processor error	Contact Hilti service
Er12	Processor error	Contact Hilti service
Er13	Error from left contactor	Contact Hilti service
Er14	Error from right contactor	Contact Hilti service
Er15	Error from star contactor	Contact Hilti service
Er16	Error from delta contactor	Contact Hilti service
Er17	Processor error	Contact Hilti service
Er18	Processor error	Contact Hilti service
Er21	Error from proportional valve	Contact Hilti service
Er22	Error from service	Contact Hilti service
Er23	Error from two-way pivot movement valve	Contact Hilti service
Er24	Error from two-way valve	Contact Hilti service
P000 or P999	The pressure sensor is defective. Control function is unsatisfactory.	Contact Hilti service

9. Troubleshooting

9.3 Other malfunctions, hydraulic unit faults

Problem	Possible cause	Action to be taken
LP 32 starts but the saw head doesn't react or doesn't react correctly	<ul style="list-style-type: none"> Hydraulic couplings not fully connected. The belt drive from the electric motor to the pump is defective. 	<ul style="list-style-type: none"> Check the hydraulic hoses, check and engage couplings. Unscrew bottom cover, check drive belt and replace it if necessary (Hilti specialist).
LP 32 starts but the saw head doesn't react or doesn't react correctly.	<ul style="list-style-type: none"> Electro-hydraulic valve(s) sticking 	<ul style="list-style-type: none"> Unscrew LP 32 front cover (Hilti specialist) Check the electric plug connections to the three valves. Check / move the slider. It may be sticking due to dirt or corrosion.
Oil leaks from hydraulic unit.	<ul style="list-style-type: none"> Oil escapes at the oil level sight glass / vent tube. 	<ul style="list-style-type: none"> Check the oil level at the sight glass. Oil level too high or LP 32 standing or hanging at an angle. Reduce blade motor speed (r.p.m.) slowly and switch off.
Water in oil, visible when oil (at sight glass) has milky-white appearance.	<ul style="list-style-type: none"> Oil seals in saw head defective Oil cooler defective Hydraulic unit not drained at temperatures below zero 	<ul style="list-style-type: none"> Check at the vent or by opening the oil drainage screw. <ul style="list-style-type: none"> → Oil clear = OK → Oil white = DANGER – unit must be serviced immediately.
Water or oil leakage at the saw arm drive flange	<ul style="list-style-type: none"> Water seal defective Oil seal defective 	<ul style="list-style-type: none"> With the saw blade stationary, allow cooling water to flow. No water should run out of the small bore. If water runs out, the water seal is defective. Return the saw head for servicing.
No power from the 230 V socket	<ul style="list-style-type: none"> 230 V supply has been overloaded. Trip switch at "OFF". 	<ul style="list-style-type: none"> Press the reset button beside the socket, trip switch in "ON" position. Total rating of appliances connected must not exceed 10 amps.

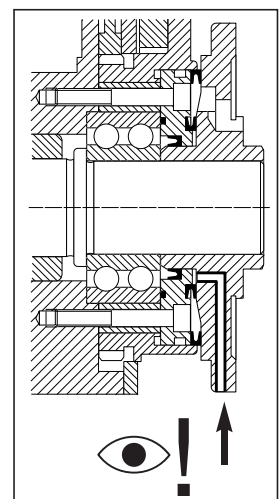
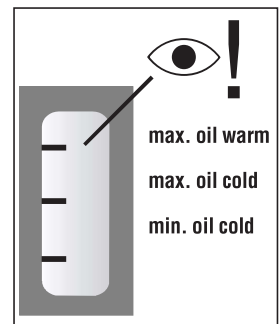
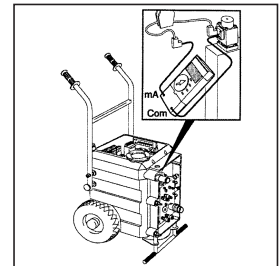
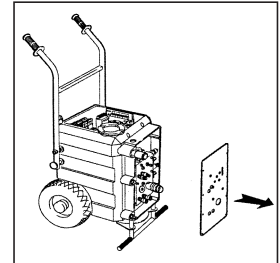

9.4 Hydraulic unit or saw system overheats / lacks power

Problem	Possible cause	Action to be taken
<p>Saw system overheats:</p> <ul style="list-style-type: none"> → Too hot to touch → Steam rises from saw head → Drop in sawing performance 	<ul style="list-style-type: none"> – Water supply inadequate, water too warm – Saw blade not cutting, segments are polished 	<ul style="list-style-type: none"> – Water flow rate at least 7 l/min. – Increase water flow rate >7 ltr./min. – The water should be cool (tap water < 20° C) – Water supply hose must be connected to lower nipple on the hydraulic unit. – Sharpen the saw blade <ul style="list-style-type: none"> → Use a sharpening plate → Alternatively, make a cut in abrasive brick or concrete with very little water.
<p>LP/TS 32 saw system</p> <ul style="list-style-type: none"> → Overheats → Sawing performance drops → Saw blade wanders off course 	<ul style="list-style-type: none"> – Cam-action rollers too tight – Cam-action rollers too loose – Play at saw head causes blade to wander – Saw blade overloaded, too soft, blade takes on blue color – Signs of friction / scoring on sides of blade – Cutting too deep – Saw blade motor speed too high – Very high steel reinforcement content, very hard concrete or hard aggregates – Unsuitable saw blade 	<ul style="list-style-type: none"> – Adjust cam-action rollers: Set levers to correct tension without play. – Mount the rails securely. See page 29. – Do not overload the saw blade. Saw at a reasonable cutting depth. – When cutting at great depth ≥60 cm (blade diameters 1500 / 1600 mm), make guide cut using 800 mm dia. blade with 5 mm wide segments. – Select the correct saw blade specification (for high power). – Run at recommended speed or oil flow rate (see table on page 39). – Reduce load (advance) slightly from time to time or allow blade to cool by running at low speed without load for 2-3 minutes. – See page 15 of operating instructions for recommended saw blades
<p>Operator</p>	<ul style="list-style-type: none"> – Saw blade running at too high speed 	<ul style="list-style-type: none"> – Observe recommended oil flow rate = Observe recommended r.p.m. See guide values on page 39.

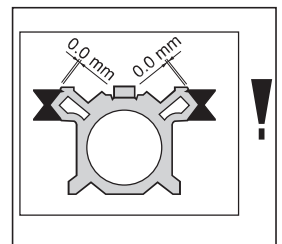
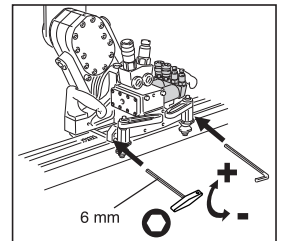
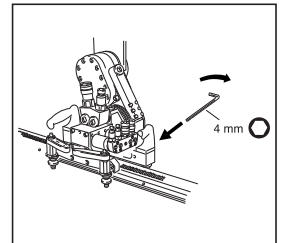

10. Disposal of the D-LP32/DS-TS32 hydraulic saw system

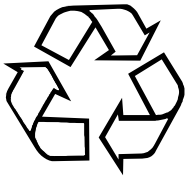

Most of the materials from which Hilti electric tools are manufactured can be recycled. The materials must be correctly separated before they can be recycled. In many countries, Hilti has already made arrangements for taking back your old electric tools for recycling. Please ask your Hilti customer service department or Hilti representative for further information.

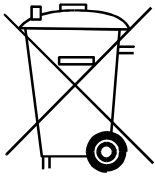

Only for EU countries

Disposal of electric tools together with household waste is not permissible!

In observance of European Directive on waste electrical and electronic equipment and its implementation in accordance with national law, electric tools that have reached the end of their life must be collected separately and returned to an environmentally compatible recycling facility.

11. Manufacturer's warranty – tools

Please contact your local Hilti representative if you have questions about the warranty conditions.

12. Declaration of conformity (original)

EC declaration of conformity (original)

Description	Hydraulic saw system
Serial numbers	Up to 9999
Designation	D-LP 32/DS-TS 32
Year of design	2001

We declare under our sole responsibility that this product complies with the following directives and standards until 19th April 2016: 2004/108/EC, from 20th April 2016: 2014/30/EU, 2006/42/EC, 2011/65/EU, EN 60204-1, EN 12100.

Hilti Corporation, Feldkircherstrasse 100, FL-9494 Schaan



Paolo Luccini
Head of BA Quality and Process Management
Business Area Electric Tools & Accessories



Johannes Wilfried Huber
Senior Vice President
Business Unit Diamond

06 / 2015

06 / 2015

Technical documentation filed at:
Hilti Entwicklungsgesellschaft mbH
Zulassung Elektrowerkzeuge
Hiltistrasse 6
86916 Kaufering
Deutschland

EC Declaration of Conformity | UK Declaration of Conformity



Manufacturer:
Hilti Corporation
Feldkircherstraße 100
9494 Schaan | Liechtenstein

Importer:
Hilti (Gt. Britain) Limited
1 Trafford Wharf Road, Old Trafford
Manchester, M17 1BY

DS-TS32 (01) | D-LP 32 (01)

Serial Numbers: 1-9999999999

2006/42/EC | Supply of Machinery (Safety)
Regulations 2008

EN 15027:2007 + A1:2009

EN 60204-1:1992

2014/30/EU | Electromagnetic Compatibility
Regulations 2016

EN 55014-1:2017 +
A11:2020

EN 55014-2:2015

2011/65/EU | The Restriction of the Use of
Certain Hazardous Substances in Electrical and
Electronic Equipment Regulations 2012

EN 61000-3-12:2011

A handwritten signature in blue ink, appearing to read "Tahar Zrilli", is placed over a light blue rectangular background.

Dr. Tahar Zrilli
Head of Quality and Process Management
Business Area Electric Tools & Accessories

Schaan, 22.07.2021

A handwritten signature in black ink, appearing to read "Johannes Wilfried Huber", is placed over a light blue rectangular background.

Johannes Wilfried Huber
Senior Vice President
Business Unit Diamond



Hilti Corporation

LI-9494 Schaan

Tel.:+423 234 21 11

Fax:+423 234 29 65

www.hilti.com

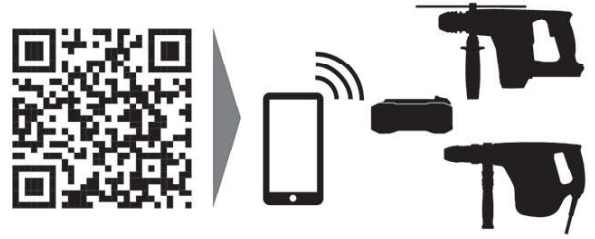

370696